

Ultrasonic level sensor

Committed to process automation solutions

Datasheet



SUP-ZP

The ultrasonic level sensor is a low-cost, non-contact and easy-to-install measurement device. It is able to meet the every-day needs of commercial production, as well serving a more specialized role in the technologically advanced aerospace industry, thus placing it firmly in the category of high-level measurement technology. Unlike other level indicators with limited uses, the easy-to-install ultrasonic level indicator is a highly accurate device with enough specialized uses to ensure that the needs of the customer are met.

Features

- ◆ Non-contact.
- ◆ Not effected by material property, such as pressure environments, viscosity and specific gravity.
- ◆ Integrated keypad with security code.
- ◆ Easy installation and low operating costs.
- ◆ Can be used in a versatile of application .
- ◆ Maintenance-free.
- ◆ Easy to set program no need to train personal.
- ◆ Fully isolated analog 4-20ma output.
- ◆ Better accuracy and stability in difficult conditions.
- ◆ Internal temperature compensation improves accuracy

Main Function

1. Level measurement
2. Distance measurement
3. Volume measurement.
4. Pump control

Principle

The principle of operation of the ultrasonic sensor system is to use the ultrasonic pulses which are transmitted by the transducer to the surface to be monitored and are reflected back to the transducer, the time period between transmission and reception of the sound pulses is directly proportional to the distance between the transducer and surface

The latest microcomputer technology and the proven processing software select the level echo from among any number of false echoes and calculate the exact distance to the product surface.

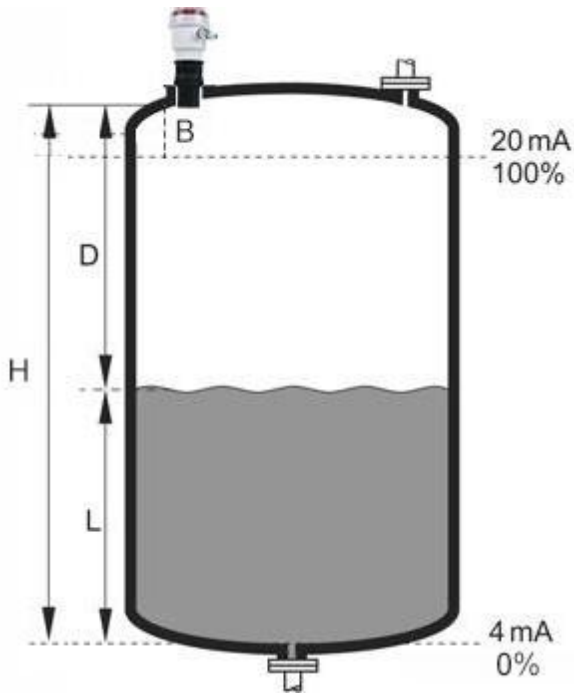

B = Blanking distance

D = Distance from transducer to material surface

L = Height in silo

The distance D is determined from the velocity of sound and the time period t by the formula:

$$D = V \cdot T / 2$$

Example:

With the velocity of sound = 334.1 M/s, a time period of 60m/s corresponds to a transmission path of 20.046M and thus to a distance of 10.023M.

An integrated temperature sensor detects the temperature in the vessel and compensates the influence of temperature on the signal running time.

Display

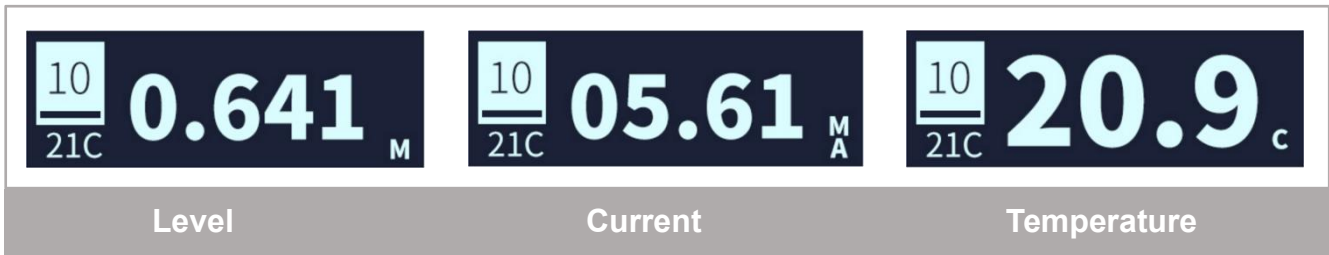

Application field

- ◆ Sewage/waste water/tapwater treatment equipment. Such as silos, open tanks , dams and wells.
- ◆ Liquids such as edible-oils, sauces and beverages.
- ◆ Chemical material such as solvent, paints, carbonic acid, water lime slurry and wax.
- ◆ Granular materials such as flour, wheat and corn.
- ◆ Chemical fibers, petrochemical materials such as plastic powders, plastic granules and plastic chips.

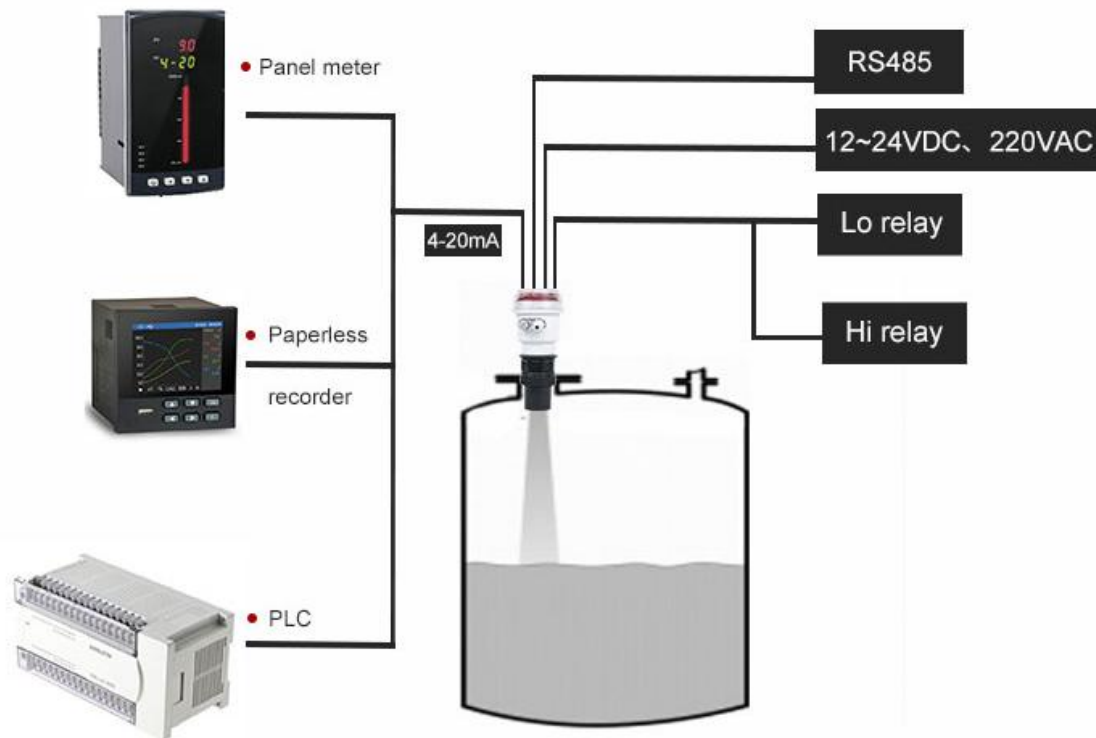

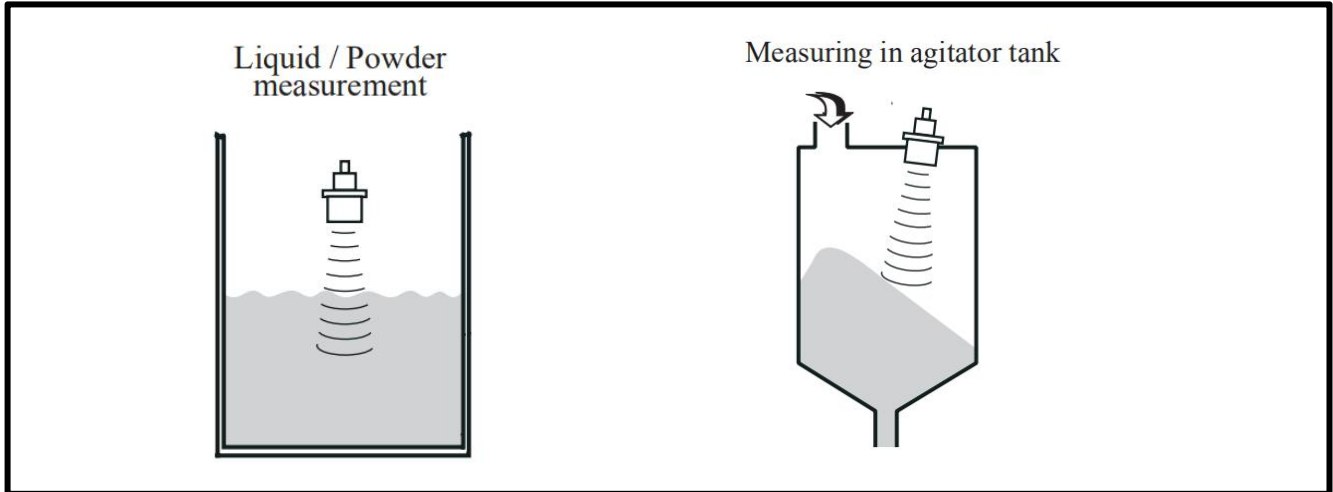

Parameter

Measure Range:	5、8、10、12、15、20、25、30m
Blind zone:	<0.4-1.8m (depending on range)
Accuracy:	0.3%F.S
Display:	OLED
Display resolution:	1mm
Frequency::	20~350KHz
Power:	12~24VDC、220VAC
Power consumption:	<1.5W
Output (optional):	4~20mA RL>600Ω (standard) 1~5V\1~10V RS485 2 NPN 2 relays (AC: 5A 250V DC: 10A 24V)
Material:	ABS
Dimension:	Φ92mm×198mm×M60/79mm×300mm×DN80
Electrical Connection:	M20X1.5
Installation:	M60X2 or Φ61MM/DN80 (Flange)
Ingress Protection:	IP65 (IP68 optional)

Installation

Keep transducer perpendicular to liquid.

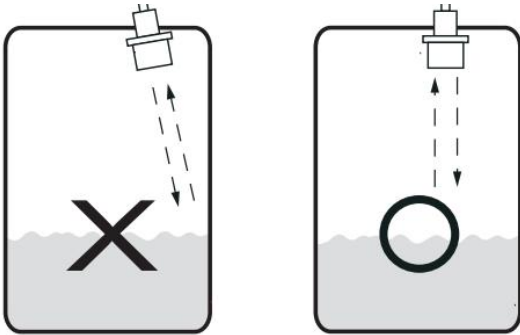

Mount the transducer away from the inlet to avoid false echoes.

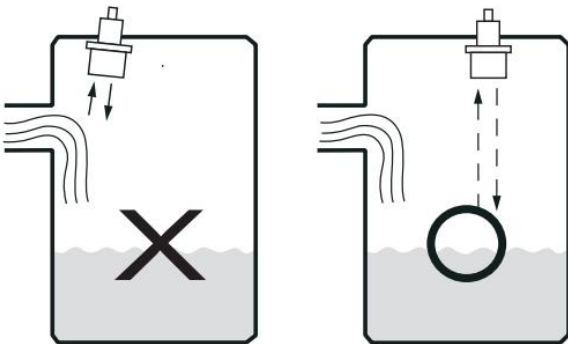

The transducer should not be mounted too close to the tank wall, the bracket can cause strong false echoes.

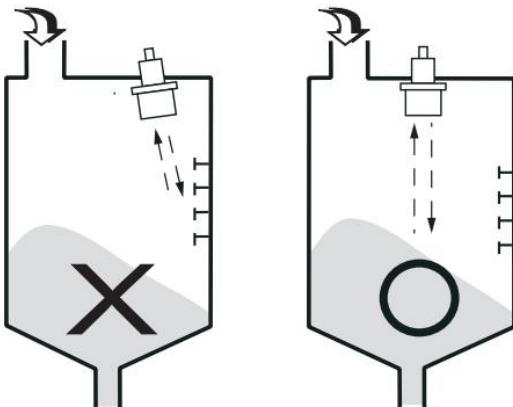

The transducer should not be mounted too close to the tank wall, the build-up on the tank wall cause false echoes.

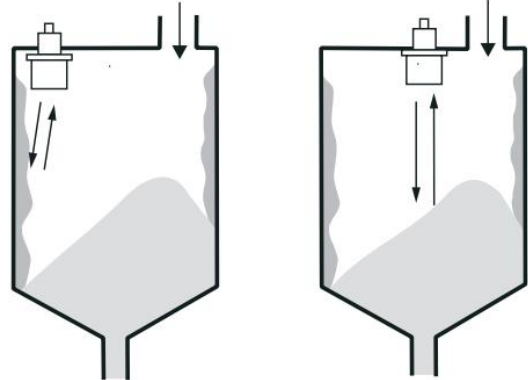

When you mount the transducer on the solid tank, the transducer must point to the tank outlet.

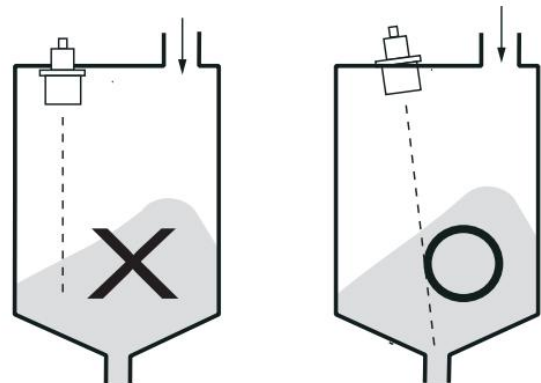

As is illustrated by the figure on the right, the transducer should be mounted on the top of guide tube to prevent the false echoes from turbulence and foam. The guide tube should come with a vent hole at top of the tube to allow the liquid vapor go out of the tube.

