

Electromagnetic flow meter

Supmea

Headquarters

5th floor, Building 4, Singapore Hangzhou Science Technology Park, No. 6 street,
Hangzhou Economic Development Area, Hangzhou 310018, China

Singapore

2 Venture Drive #11-30 Vision Exchange Singapore

Philippines

Majestic Subdivision, Lot 1, 1800 Rainbow St, Marikina, 1811 Metro Manila, Philippines

✉ info@supmea.com

🌐 www.supmea.com

Supmea Automation Co., Ltd.

Preface

Thank you for purchasing electromagnetic flow meter. Please read this manual carefully before operating and using it correctly to avoid unnecessary losses caused by false operation.

Note

- Modification of this manual's contents will not be notified as a result of some factors, such as function upgrading.
- We try our best to guarantee that the manual content is accurate, if you find something wrong or incorrect, please contact us.
- This product is forbidden to use in explosion-proof occasions.

Version

U-PDCLDG-MYEN3

Contents

Chapter 1 Safety instructions.....	1
1.1. Manufacturer's safety Instructions.....	1
1.1.1. Copyright and data protection.....	1
1.1.2. Exemption clause.....	1
1.1.3. Product liability and warranty.....	2
1.1.4. Document details.....	2
1.1.5. Display convention.....	3
1.2. Safety instructions for operators.....	3
Chapter 2 Introduction.....	4
2.1. Scope of delivery.....	4
2.2. Measuring principle.....	6
2.3. Mechanical Construction.....	7
2.4. Application introduction.....	8
2.5. Wiring introduction.....	9
2.6. Nameplate.....	11
Chapter 3 Installation.....	12
3.1. Installation tips.....	12
3.2. Storage.....	12
3.3. Pipeline design.....	12
3.4. Pipe design.....	12
3.5. Installation conditions.....	15
3.6. Mechanical installation.....	19
3.6.1. Installation of flowmeter pipeline.....	19
3.6.2. Precautions.....	20
3.6.3. Installation of flowmeter.....	22
3.7. Dimensions for electromagnetic flowmeter.....	23
Chapter 4 Electrical connection.....	25
4.1. Safety tips.....	25
4.2. Connect signal and magnetic field current cable.....	25
4.3. Potential Equalization.....	27
4.4. Power supply.....	27
4.5. Output termination.....	29
Chapter 5 Start up.....	31
5.1. Power on.....	31
5.2. Converter start up.....	31
Chapter 6 Operation.....	32
6.1. Display and operating elements.....	32

6.2. Display (operation mode).....	33
6.3. Display button operation instructions.....	34
6.4. Quick setup menu.....	34
6.5. Configuration details.....	35
6.6. Brief operating instruction and function.....	46
6.6.1. Parameter selection and adjustment.....	46
6.6.2. Display measurement.....	47
6.6.3. Flow setup and analog output menu.....	48
6.6.4. Pulse output and total set menu.....	49
6.6.5. Relay out setup menu.....	49
6.6.6. System function, empty pipe function, sensor function, test function setup menu.....	50
Chapter 7 Display Functions.....	51
7.1. System Information.....	51
7.2. Pulse/Frequency/Current Output.....	52
7.2.1. Pulse equivalent output.....	52
7.2.2. Frequency Output.....	53
7.2.3. Current Output.....	53
7.3. Communication.....	53
7.3.1. Registered Address.....	54
7.3.2. Communication Configuration.....	55
7.3.3. ReadoutReal-time Quantity Floating-point Communications Example.....	55
Chapter 8 Technical Parameters.....	56
8.1. Technical Parameters.....	56
8.2. Electrode selection and specification.....	59
8.3. Flowmeter.....	60
8.4. Flow and Velocity Parallel Table for Electromagnetic Flowmeter.....	61
8.5. Accuracy.....	62
Chapter 9 Plug-in type electromagnetic flowmeter series.....	63
9.1. The functional use and scope of application of the product.....	63
9.2. Product form and composition.....	64
9.3. Main technical specification.....	64
9.4. Structure.....	65

Chapter 1 Safety instructions

1.1. Manufacturer's safety Instructions

1.1.1. Copyright and data protection

The content of this document has been checked carefully, but we do not guarantee that the contents are totally accurate and it is in accordance with the latest version. The contents and works of this document are under China's copyright protection. Any copy, processing and transmission of it out of the scope of copyright, in any forms, must get the written permission of the authors or the manufacturer. Manufacturers always try to respect the copyrights of others, and try to use their own works or works without authorization.

Personal data (such as name, address or E-mail address) used in manufacturer' s documents, if possible, are conducted on a voluntary basis. Use of products and services, if possible, starts without having to provide personnel data. We remind you: data transmission on the Internet (such as communicating via email) may possibly meet security vulnerabilities. We can't give security guarantee that data will definitely not be obtained by a third party. Here, we are clearly against the third party using contact data, within the scope of copyright notice obligation, to send advertising materials without any requirement.

1.1.2. Exemption clause

The manufacturer will not bear the responsibility for any forms of loss caused by using the product; these consequences include direct, indirect or accidental losses as well as these coming from punishment, but not limited to these consequences. If the manufacturer has intentional behavior or gross negligence, the disclaimer is invalid. If it is not allowed to limit the product' s self assurance, nor is it allowed to waive or limit certain types of compensation, and these rights are suited for you as well according to applicable laws, in this case the above disclaimer or limitations may partially or completely not apply to you. For every purchase of products, they are applicable to product documentation and

manufacturer's sale terms.

As for document contents including this disclaimer, the manufacturer reserves and has the right to modify at any time in any way for any reason without any notice in advance, and it will not bear the responsibility for the consequences coming out of any forms of change.

1.1.3. Product liability and warranty

The operator judges whether the flow meter serves the purpose, and bear the responsibility for it. The manufacturer does not assume the consequences caused by operator's misuse of meter. Wrong installation and operation of flowmeter (system) will lead to deprive of warranty rights. In addition, the corresponding 'standard sales terms' applies as well, and the clause is the basis of purchase contract.

1.1.4. Document details

In order to avoid harm or damage to the equipment when used improperly, please make sure reading the information in this document before using it. In addition, you must comply with national standards, safety regulations and accident prevention rules.

If you can't understand this document, please ask the manufacturer for help. The manufacturer will not take the responsibility for property loss or physical injuries due to misunderstanding of the information contained in the document.

This document will help you to establish favorable operating conditions so as to make sure that you use the equipment in a safe and effective way. In addition, something of particular attention and safety measures in the document are marked by the following marks.

1.1.5. Display convention

The following symbols will make it easier for you to use this document.



Danger!

This symbol signifies related and important safety tips.



Warning!

Such warnings must be paid attention to. Slight negligence may lead to serious health threat, and may damage the equipment itself or the operating factory facilities.



Note!

Such warnings must be paid attention to. Any slight negligence may also lead to functional fault of the equipment itself.

1.2. Safety instructions for operators



Warning!

Only corresponding personnel who got trained and authorized is allowed to install, use, operate and maintain the equipment. This document will help you to establish favorable operating conditions so as to make sure that you use the equipment in a safe and effective way.

Chapter 2 Introduction

2.1. Scope of delivery



Tips!

Please check whether the boxes are damaged or not, and whether they have been handled roughly or not. Please report the damage to the deliverer and the manufacturer.



Note!

Please check the packing list to make sure that all the goods you received are integrated.



Note!

Please check the nameplate of the equipment, and confirm whether the delivered contents are consistent with the order, and check whether the voltage indicated on the nameplate is correct. Otherwise, please contact manufacturer or supplier.

(1) Remote type flowmeter

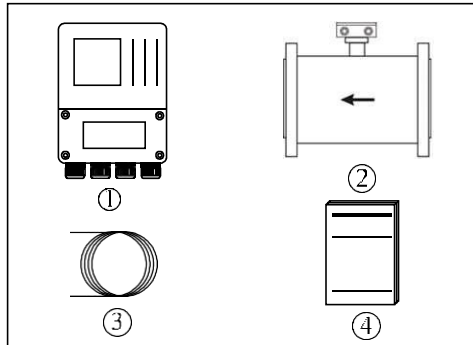

Figure 1

- ① Remote type flowmeter signal converter
- ② Remote type electromagnetic flowmeter sensor

- ③ Signal cable
- ④ User manual

(2) Compact type flowmeter (DN65, refer to type selection manual for specific parameters)

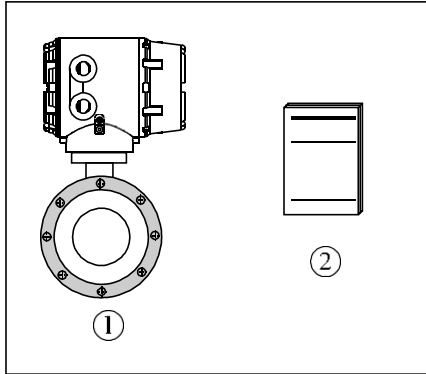

Figure 2

- ① Compact type electromagnetic flowmeter
- ② User manual

2.2. Measuring principle

The operating principle of electromagnetic flowmeter is based on Faraday's law of electromagnetic induction. The two electromagnetic coils at the upper and lower ends as shown in Figure 3 generate a constant or alternating magnetic field. When the conductive medium flows through the electromagnetic flowmeter, the induced electromotive force can be detected between the left and right electrodes on the wall of the flowmeter tube. The magnitude of the induced electromotive force is proportional to the electrically conductive medium flow rate, the magnetic induction density of the magnetic field, and the width of the conductor (the inner diameter of the flowmeter measuring tube), and the flow rate of the medium can be obtained by calculation. The induced electromotive force equation is as follows:

$$E=K \times B \times V \times D$$

Where: E—Induced electromotive force

K—Meter constant

B—Magnetic induction density

V—Average flow speed in cross-section of measuring tube

D—Inner diameter of measuring tube

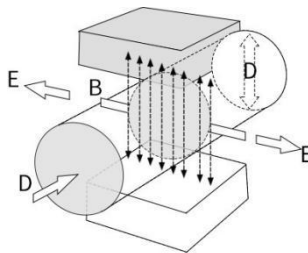

Figure 3

When measuring the flow, the fluid flows through a magnetic field which is perpendicular to the flow direction. The flow of conductive fluid induces a potential proportional to the average flow velocity, thus requiring the conductivity of the measured flowing liquid to be higher than the minimum conductivity (5 μ s/cm). The induced voltage signal is detected by two electrodes and transmitted to the

converter via a cable. After a series of analog and digital signal processing, the accumulated flow and real-time flow are displayed on the display of the converter.

2.3. Mechanical Construction

The electromagnetic flowmeter is mainly consisted of the following parts, see Figure 4.

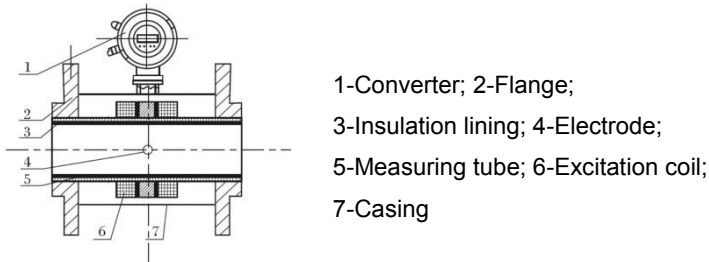

Figure 4

The electromagnetic flowmeter mainly consists of a sensor and a converter. The sensor includes a flange, a lining, an electrode, a measuring tube, an excitation coil, and a sensor casing, etc; the converter includes an internal circuit board and a converter casing.

- (1) Converter: Provide stable excitation current for the sensor, meanwhile amplify the induced electromotive force obtained by the sensor and convert it to standard electrical signals or frequency signals; at the same time, it displays real-time flow and parameters for displaying, controlling and adjusting thereof.
- (2) Flange: for connecting process piping.
- (3) Lining: Refer to a complete layer of electrically insulating corrosion resistant material located at the inner side of measuring tube and flange sealing surface.
- (4) Electrode: A pair of electrodes is installed on the wall of the measuring tube which is perpendicular to the magnetic line to detect the flow signal. The material of electrode can be selected according to the corrosion

performance of the measured medium. It is also equipped with 1-2 grounding electrodes for grounding and anti-interference of flow signal measurement.

- (5) Measuring tube: The measured medium flows through the measuring tube. It is made by welding non-magnetic stainless steel and flange, and the inner side is equipped with insulation lining.
- (6) Excitation coil: A group of coils is arranged on the upper and lower side of external side of the measuring tube respectively to generate a working magnetic field.
- (7) Casing: Protect and seal the meter.

2.4. Application introduction

Electromagnetic flowmeter applies only to measure the real-time flow rate of an electrically conductive liquid or liquid-solid two-phase flow, and has a flow accumulation function. Theoretically, an ordinary type electromagnetic flowmeter can measure the medium conductivity of not less than $5 \mu\text{S/cm}$, but it's proved that the measured conductivity by the ordinary electromagnetic flowmeter is higher than one to two orders of magnitude, at least more than $50 \mu\text{ S/cm}$. Meanwhile, the conductivity measured online must prevail, for that measured offline may be relatively higher due to carbon dioxide and nitrogen dioxide contained in the air may dissolve into the medium.

2.5. Wiring introduction

(1) Remote type

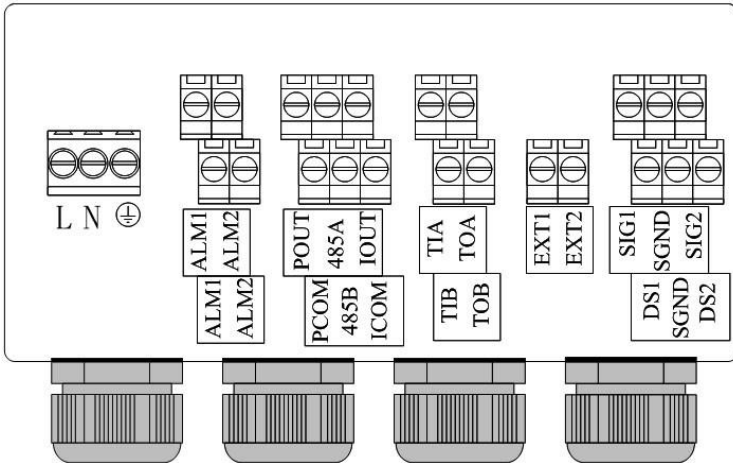



Figure 5

L, N:	100-240VAC power supply
 :	Ground
ALM1, ALM2:	Relay out
POUT, PCOM:	Pulse/Frequency output
485A, 485B:	RS485 communication
IOUT, ICOM:	4-20mA output
EXT1, EXT2:	Excitation signal
SIG1, SIG2, SGND:	Electrode signal
DS1, DS2:	Electrode shield

(2) Compact type

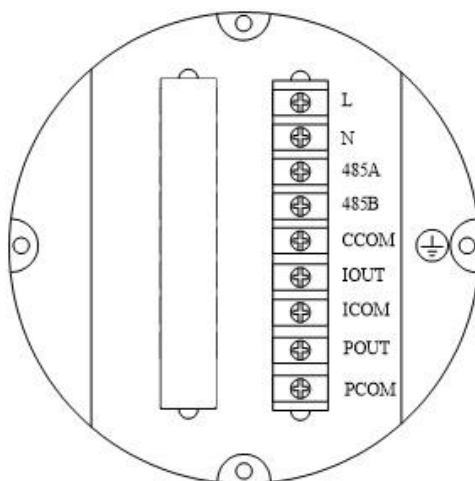

Figure 6

L, N:	100-240VAC power supply
485A, 485B:	RS485 communication
IOUT, ICOM:	4-20mA output connection
POUT, PCOM:	Pulse/Frequency/Relay out
CCOM:	RS485 communication ground
⊥ :	Converter instrument grounding protection

2.6. Nameplate



Note!

Please check the nameplate of the equipment and confirm whether the delivered contents are consistent with your order.

The ex-factory parameters of the meter are preset according to the requirements of the order, thus users are not required to set the parameters prior to operation.

Instead, you need to check whether the parameters indicated on the nameplate are correctly preset against with the actual working conditions.

The following are parameters on the nameplate.

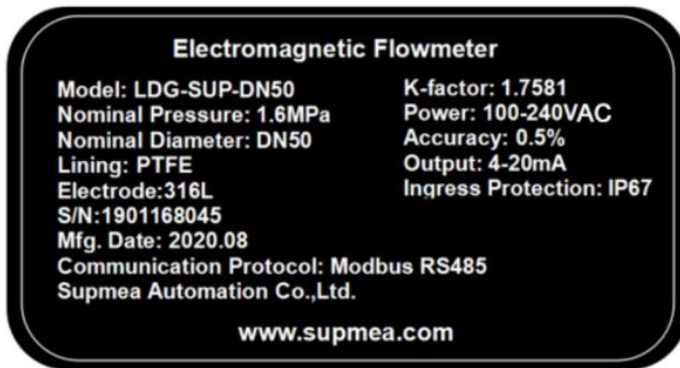

Figure 7

It is strictly prohibited to open the cover with electricity

Chapter 3 Installation

3.1. Installation tips



Note!

Please check whether the boxes are damaged or not, and whether they have been handled roughly or not. Please report the damage to the deliverer and the manufacturer.



Note!

Please check the packing list to make sure the goods that you receive is complete.



Note!

Please check the instrument nameplate, and confirm whether the delivered contents are consistent with your order. Check whether the power supply indicated on the nameplate is correct. If not correct, please contact the manufacturer.

3.2. Storage

- (1) The instrument shall be stored in a dry and clean place.
- (2) Avoid exposure in direct sunlight for long.
- (3) Instrument shall be stored in the original package.

3.3. Pipeline design

The following items shall be considered when the pipes are designed.

- (1) Leave enough space on the side.
- (2) Do not make the electromagnetic flowmeter subject to violent vibration.

3.4. Pipe design

(1) Location

- ① The electromagnetic flowmeter shall be installed in a dry and ventilated place. A place easy for water accumulation shall be avoided.

- ② The electromagnetic flowmeter shall avoid the sunshine and rain. When it is installed outdoors, it shall be equipped with facilities against sunshine and rain. The ambient temperature ranges from -20°C to +60°C.
- ③ The electromagnetic flowmeter shall not be installed in places with large temperature variation and avoid high temperature radiation from the equipment. If it must be installed therein, heat insulation and ventilation measures shall be taken.
- ④ The electromagnetic flowmeter shall avoid installing in an environment containing corrosive gases. If it must be installed therein, ventilation and anti-corrosion measures shall be taken.
- ⑤ The electromagnetic flowmeter shall be installed avoiding strong vibration as possible, such as violent pipe vibration. In this case, brackets for fixing pipes on both sides of electromagnetic flowmeter shall be provided.
- ⑥ Part of the sensor of electromagnetic flowmeters with IP68 (3 m under water) protection level can be placed into the water. While the electromagnetic flowmeter with IP65 protection level cannot be immersed into the water or installed outdoors.

(2) Avoid interference of magnetic field

Do not install electromagnetic flowmeters near motors, transformers, or other power sources which are prone to cause electromagnetic interference, near the frequency converter or obtain power from the power distribution cabinet of the frequency converter to avoid interference.

(3) The distance of the straight pipe

In order to ensure the measurement accuracy of flowmeter, it is recommended to ensure that the length of the straight pipe on the upstream of the sensor shall be at least 10 times of pipe diameters (10D), and the length of straight pipe on the downstream be at least 5 times of pipe diameters (5D)

(4) Maintenance space

For the convenience of installation and maintenance, enough installation space shall be reserved around the electromagnetic flowmeter.

(5) For pipes that do not allow flow disruption in the process

When installing the electromagnetic flowmeter, bypass pipes and cleaning ports shall be added. As shown in Figure 10, these devices can ensure the continuous operation of equipment system when the flowmeter is out of service.

(6) Support of electromagnetic flowmeter

Do not install the electromagnetic flowmeter on a free-vibrating pipe without any support. Instead, a mounting base shall be used to secure the measuring tube. When the electromagnetic flowmeter is required to be installed underground, the pipes at both inlet and outlet ends shall be provided with support items, and a metal protection plate shall be installed above the flowmeter.

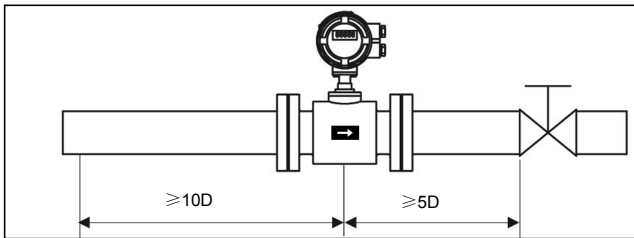

Figure 8

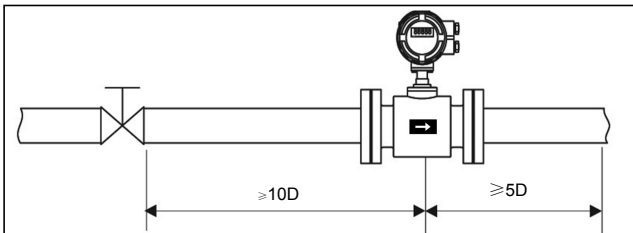

Figure 9

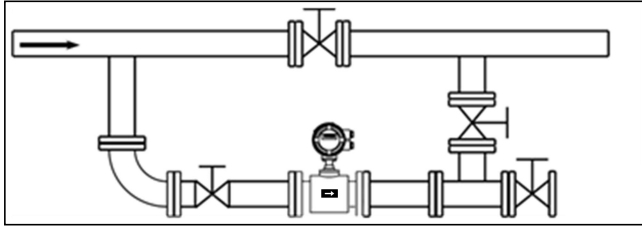

Figure 10

3.5. Installation conditions

(1) Flow direction

The flowmeter can be set to automatically detect the positive and negative flow direction. The flow direction arrow on the sensor casing indicates the positive flow direction specified by the manufacturer. Generally, when installing the meter, the user shall make the flow arrow consistent with the on-site process flow.

Figure 11 shows the preferred location for installing the electromagnetic flowmeter.

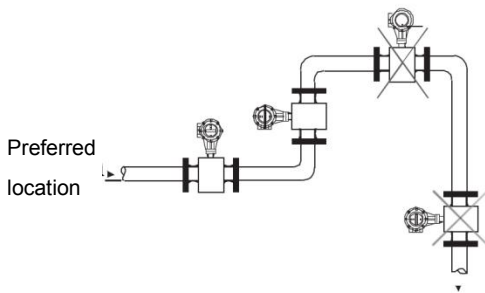

Figure 11

The pipe is routed to the highest point (Bubble accumulation in the measuring tube is likely to cause produce measurement errors!)
It is easy to cause a non-full tube measurement error!

(2) Installation direction of electromagnetic flowmeter and sensor electrodes

The sensor allows horizontal and vertical installation. When it's installed

horizontally, the electrode shall be horizontally placed such that bubbles will not be adsorbed near the electrode in case that the medium is contained with bubbles or precipitates. Otherwise, this would cause converter signals opened and zero drift due to the fact that deposits are not covered by the electrode.

(3) Liquids shall always be filled with pipes.

Pipes shall be arranged to ensure that the electromagnetic flowmeter measuring tube is always filled with liquids.

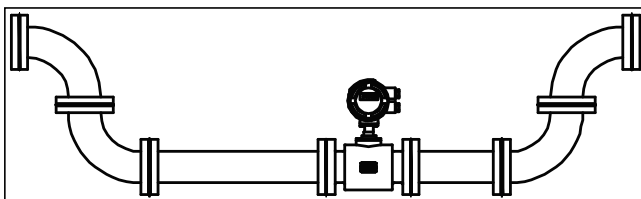

Figure 12

For liquids or slurries containing solid particles, it is suggested to vertically install the electromagnetic flowmeter. For one thing, the phase separation of measured medium can be prevented; for another, the sensor lining are worn evenly. In addition, impurities will not precipitate at the bottom of the measuring tube. It shall be guaranteed that liquids flow from bottom to top to ensure that the sensor measuring tube is always filled with medium.

(4) The electromagnetic flowmeter cannot be installed on the suction side of the pump.

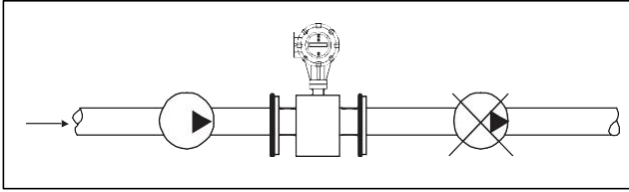

Figure 13

(5) For long pipelines, control valves are generally installed on the downstream of the electromagnetic flowmeter.

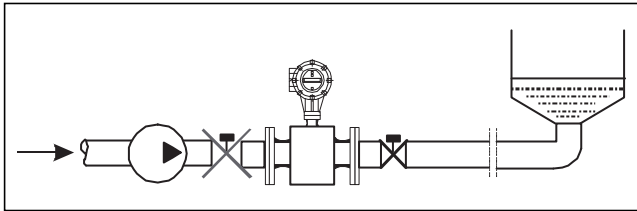

Figure 14

(6) For pipes with open discharges, the electromagnetic flowmeter shall be installed at the bottom section (lower part of the pipe).

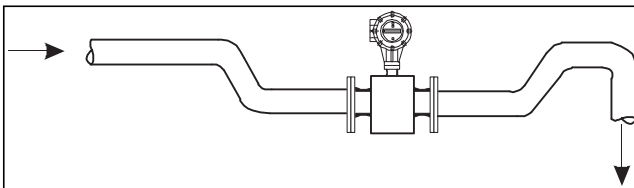

Figure 15

(7) For places where fall head of pipes is over 5 m, the air valve shall be installed on the downstream of the electromagnetic flowmeter.

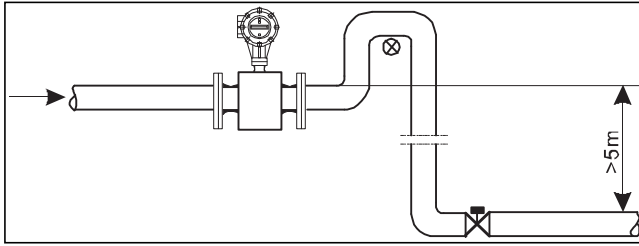

Figure 16

(8) Measurement error caused by incidental gas and damage of lining caused by vacuum shall be avoided

(9) No bubbles shall be observed in the pipes.

Pipes shall be designed to prevent the air bubbles in the fluids from accumulating the measurement pipe of a sensor. If a valve exists near the flowmeter, try to mount the flowmeter on the valve's upstream side for preventing a decrease of pressure inside the pipe possibly, consequently avoiding the possibility of air bubbles. ensure that no gas can be separated from the liquid.

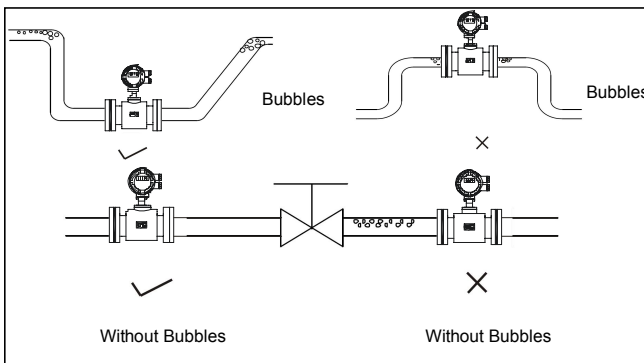

Figure 17

(10) Liquid conductivity

It's not allowed to install the electromagnetic flowmeter at a place where the liquid conductivity is extremely uneven. Injection of chemicals from the upstream of the meter can easily result in uneven liquid conductivity, which can cause serious

interference to the meter flow indication. In this case, it is recommended to inject chemicals from the downstream of the meter; if chemicals must be injected from the upstream of the meter, it must be ensured that the straight pipe section on the upstream at least has 30 times of pipe diameters to ensure adequate mixing of liquids.

(11) Grounding

As the voltage of induced signal of electromagnetic flowmeter is small, it's more prone to be affected by noises or other electromagnetic signals. This is why the electromagnetic flowmeter needs to be grounded in many occasions. This functions to form an internal space for shielding external interference through the grounding of flowmeter casing, thereby improving measurement accuracy.

3.6. Mechanical installation

3.6.1. Installation of flowmeter pipeline

(1) Prior to installation, the pipeline shall be calibrated to ensure that the diameter of the meter has good coaxiality with the user's pipeline. For sensors with a nominal diameter of no more than 50mm, the protrusion of its axis shall not exceed 1.5 mm; for sensors with a nominal diameter of 65~300 mm, it shall not exceed 2mm and for sensors with a nominal diameter of no less than 350 mm, it shall not exceed 4 mm.

(2) In general, foreign matters (such as welding slag) may exist in newly installed pipelines. Before the flowmeter is installed, wash away the debris. It not only prevents the lining from being damaged but also measurement error caused by foreign matters which pass through the measuring tube during measurement.

3.6.2. Precautions

Operating introduction:

(1) Take care to avoid damage to the meter when you are unpacking. It is suggested not to unpack the box before transporting it to the installation site to avoid damage of meter. It's prohibited to use a stick or rope to lead through the measuring tube of sensor. Instead, follow the correct lifting as shown in the figure below.

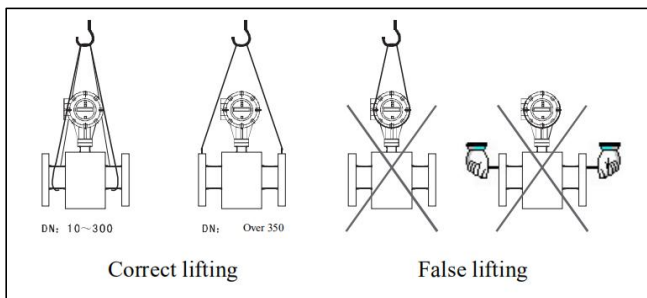

Figure 18

(2) Avoid vibration

Avoid heavy falling or pressing, especially the flange surface which cannot be stressed (otherwise, the lining may be damaged to disable operation of the meter).

(3) Protection of flange surface

After unpacking, pay attention to protect the flange. Do not place it on the unpadded floor or other uneven boards.

(4) Terminal box

It's not allowed to open the terminal box cover before electrical wiring. After the wiring is completed, please apply the special sealant provided by our company to on the terminal box as soon as possible. Then cover terminal box and tighten the screws to ensure the tightness.

If the protection level of the electromagnetic flowmeter is IP68 at type selection, it has been subject to water-proof sealing.

(5) No operation for long duration

After the instrument is installed, it shall be avoided that the meter is not used for long duration. If yes, please take the following measures:

- A. Check the tightness of the covers and the wiring terminals to ensure that no moisture and water enters into the meter.
- B. Conduct regular inspection. Check against the measures mentioned above and the terminal box for at least once a year. In the event of water entry into the meter (eg, after heavy rain, etc.), the meter shall be inspected immediately.

3.6.3. Installation of flowmeter

(1) Installation direction

The flow direction of the measured fluid shall be consistent with flow direction mark indicated on the flowmeter.

(2) Washers installed between flanges shall have good corrosion resistance and shall not protrude into the interior of the pipe.

(3) When welding or flame cutting is performed adjacent to sensor pipe, isolation measures shall be taken to prevent the lining from being deformed due to heat.

(4) If it is installed in a well or immersed in water, apply sealant on the terminal box of the sensor after the system is installed and debugged. (If the protection level of the electromagnetic flowmeter is IP68 at type selection, it has been subject to water-proof sealing.)

(5) When the flowmeter is installed on the field, use bolts to connect the flange on the sensor to that on the pipe. Bolts, nuts and their threads for securing meters shall be complete and free of damage and well lubricated. Use them with suitable flat washers and spring washer. A torque wrench shall be used to tighten the bolts according to the flange size and torque. Regularly tighten the bolts during daily use to prevent looseness of the bolts.

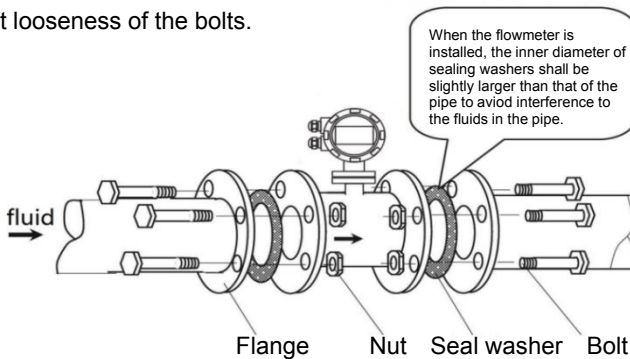
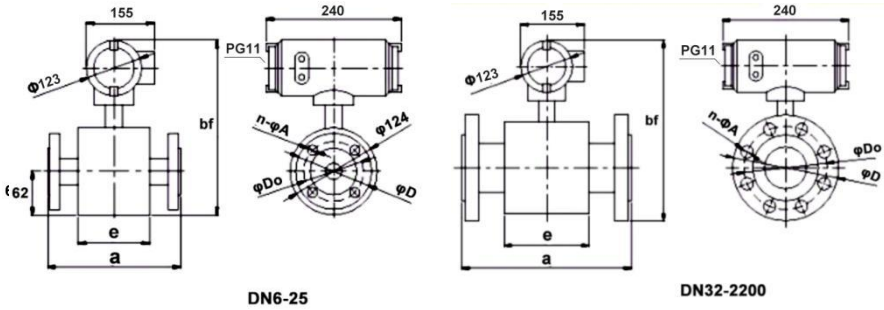

Figure 19

3.7. Dimensions for electromagnetic flowmeter



DN	flowmeter(mm)			Flange (mm)			Pressure (Mpa)
	a	bf	c	D	Do	n*A	
6	102	252	62	76	58	4-φ7	4
10	150	322	82	90	60	4-φ14	
15	150	322	82	95	65	4-φ14	
20	150	322	78	105	75	4-φ14	
25	150	312	78	115	85	4-φ14	
32	150	327	74	135	100	4-φ18	
40	150	335	74	145	110	4-φ18	
50	200	354	86	160	125	4-φ18	
65	200	366	92	180	145	8-φ18	
80	200	385	92	195	160	8.φ18	
100	250	406	114	215	180	8-φ18	1.6
125	250	436	114	245	210	8-φ18	
150	300	465	136	280	240	8-φ23	
200	350	518	156	335	295	8-φ23	1
250	400	570	202	390	350	12-φ23	
300	500	620	230	440	400	12-φ23	

350	500	675	278	500	460	16-φ23	
400	600	733	320	565	515	16-φ25	
450	600	782	374	615	565	20-φ25	
500	600	835	388	670	620	20-φ25	
600	600	940	408	780	725	20-φ30	
700	700	1048	520	895	840	24-φ30	
800	800	1160	580	1010	950	24-φ34	
900	900	1260	660	1110	1050	28-φ34	
1000	1000	1370	720	1220	1160	28-φ34	
1200	1200	1585	1130	1405	1340	32-φ34	
1400	1400	1810	1260	1630	1560	36-φ36	
1600	1600	2040	1450	1830	1760	40-φ36	
1800	1800	2250	1640	2045	1970	44-φ39	
2000	2000	2460	1820	2265	2180	48-φ42	

Chapter 4 Electrical connection

4.1. Safety tips



Danger!

Only when the power is switched off, can we do all the work about electrical connections. Please pay all attention to the power supply on the nameplate!



Danger!

Please observe national installation regulations



Warning!

Please strictly observe local occupational health and safety regulations. Only those who have got properly trained are allowed to operate on the electrical equipment.



Tips!

Please check the nameplate of the equipment, and confirm whether the delivered contents are consistent with your order, and check whether the voltage indicated on the nameplate is correct. Otherwise, please contact manufacturer or supplier.

4.2. Connect signal and magnetic field current cable



Danger!

Only when the power is cut off can you connect signal and magnetic field current conductor.



Danger!

The equipment must be grounded in accordance with regulations so as to protect the operator from electrical shock.



Danger!

In case that equipment is used in explosion danger areas, special notes are given to explosion-proof instructions for safety tips.



Warning!

Please strictly observe local occupational health and safety regulations. Only those who have got properly trained are allowed to operate on the electrical equipment.

- (1) **Compact type (caliber: 65, refer to type selection manual for specific parameters)**

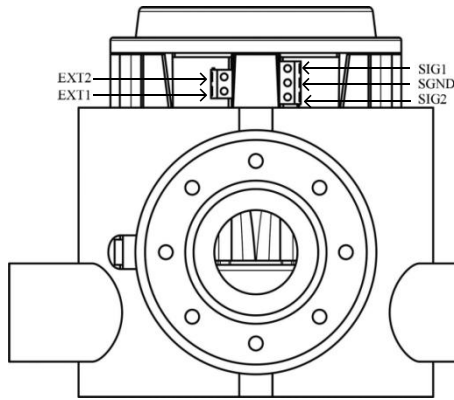

Figure 20

Connection description

- ① Excitation output: EXT1--Sensor excitation coil positive terminal
EXT2--Sensor excitation coil negative terminal
- ② Signal output: SIG1-The positive electrode sensor signal
SIG2--The negative electrode sensor signal
SGND--Signal ground

4.3. Potential Equalization



Danger!

No potential difference is allowed between the measuring sensor and casing or protective earth of converter. The electromagnetic flowmeter must be grounded separately during operation. If it is grounded with other instruments or electrical devices, the leakage current may cause serial-mode interference to the measurement signal, or in a serious case, the electromagnetic flowmeter cannot work.

- (1) The measurement sensor must be correctly grounded.
- (2) The grounding conductor shall not transmit any interference voltage.
- (3) It is not allowed to connect other electrical equipment to the grounding conductor at the same time.

4.4. Power supply



Danger!

The equipment must be grounded in accordance with regulations so as to protect the operator from electrical shock.

(1) 100-240VAC power supply

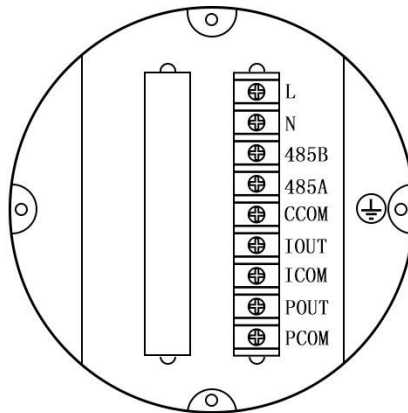

Figure 21



Tips!

Allowable range: 100VAC -240VAC, 50Hz-60Hz

- ① L: AC live line
- ② N: AC neutral line
- ③ : Connect ground wire to the ground screw

(2) 24VDC power supply

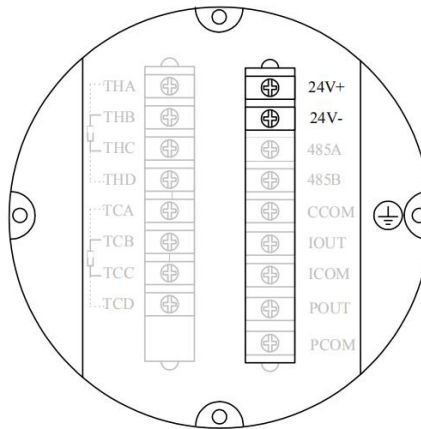

Figure 22



Tips!

Allowable range: 22VDC -26VDC

- ① 24+: 24VDC Power supply positive pole
- ② 24-: 24VDC Power supply negative pole
- ③ : Connect ground wire to the ground screw.

4.5. Output termination



Warning!

The meter can only be installed, used, or operated by trained and authorized persons. This document will help you to establish favorable operating conditions so as to make sure that you use the equipment in a safe and effective way.

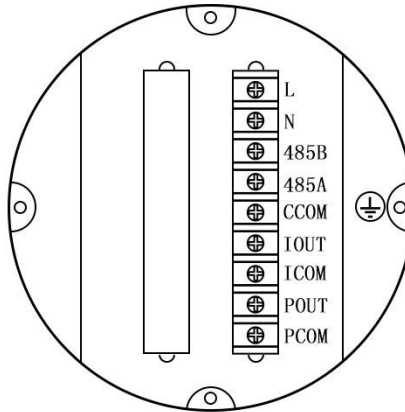

Figure 23

Current output

- ① IOOUT, ICOM: 4-20mA output connection

Communication output

- ② 485A, 485B: RS485 communication output
- ③ CCOM: RS485 communication ground
- ④ Protocol: ModBus-RTU

Pulse, frequency output and relay out

- ① Pulse output: POUT, PCOM
- ② Relay out : ALM1, ALM2
- ③ Active mode: High 24V, 5mA drive current
- ④ Output electrical isolation: photoelectric isolation, isolation voltage: > 1000VDC

⑤ Scale

Frequency output: Frequency 2KHz (configurable 0-5 kHz), corresponding to the upper limit of the flow range

Pulse output: corresponding flow rate volume of each pulse (configurable) ; output pulse width: 0.1ms ~100ms , space ratio:1:1; $F_{max} \leq 5000$ cp/s

Electric wiring diagram 750Ω under load; $I_{max} \leq 22$ mA Current flow percent

⑥ Electric wiring diagram

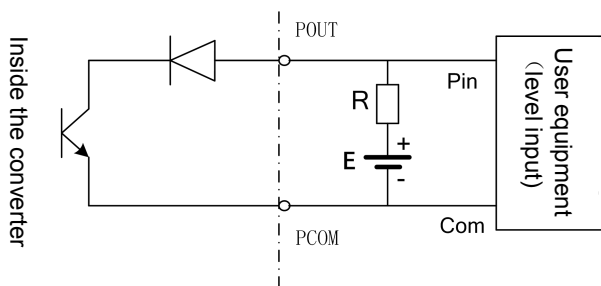

Figure 24

Additional remarks: pulse output is OC gate output, it needs external power supply. The general counters are equipped with pull-up resistors, and the signal can be directly connected therein.

Manufacturer's suggestion: use a pull-up resistor R of 2K, 0.5W, and 24V DC power supply for power supply

Chapter 5 Start up

5.1. Power on

Please check whether the installation is correct before power on, including:

- ① The meter must be installed following safety compliance.
- ② Power supply connection must be performed in accordance with the regulations.
- ③ Please check the electrical connection in the power supply is correct.
- ④ Tighten the converter shell back cover.
- ⑤ Tighten the back cover of the converter housing

5.2. Converter start up

The measuring instrument is consisted of measuring sensor and signal converter; the delivery can be put into service. All parameters and hardware are configured according to your order.

After energization, the instrument will perform self-check for one time.

Then it will immediately begin to measure and display the current values.

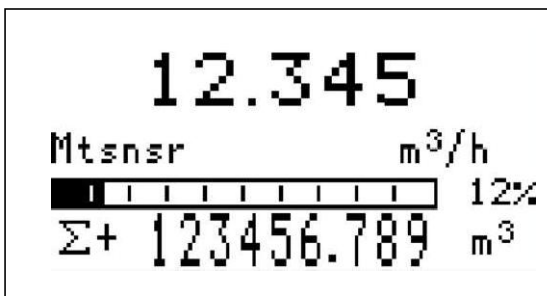

Figure 25 Startup interface

Chapter 6 Operation

6.1. Display and operating elements

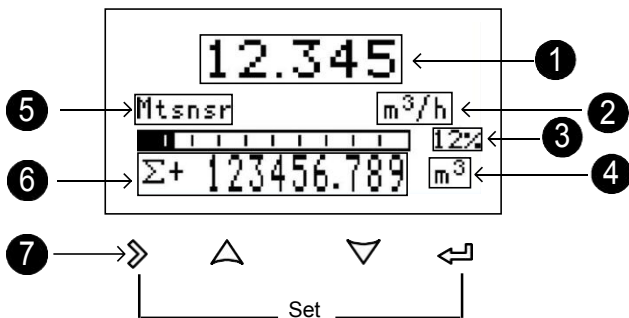

Figure 26

- (1) Real-time flow
- (2) Real-time flow unit
- (3) Real-time flow in percent of flow
- (4) Accumulation flow unit
- (5) System alarm information
- (6) Cumulative amount and so on

Display information[$\Sigma+$: Positive flow accumulation, $\Sigma-$: Negative flow accumulation, Σ : Net flow accumulation, V: current flow rate, MT: Current conductivity]

- (7) Operation keys: mechanical / photoelectric keys

Mark	Measuring mode	Menu mode	Function mode	Data mode
>	-	Switch menu categories	-	Data right shift
↵	Switch accumulative amount	Switch menu subclass	Confirmation	Confirm data

↑ ↓	-	-	Selection	Change data
> +↓	Enter menu	Exit menu	-	-

6.2. Display (operation mode)

Photoelectric key operation: use a finger to click on the icon  for more than half a second and release to finish button operation for once.

Except key combination, it is forbidden to put other fingers on the other photoelectric keys when operating the touch-key.

Photoelectric keys are optional, please see type selection manual for details.

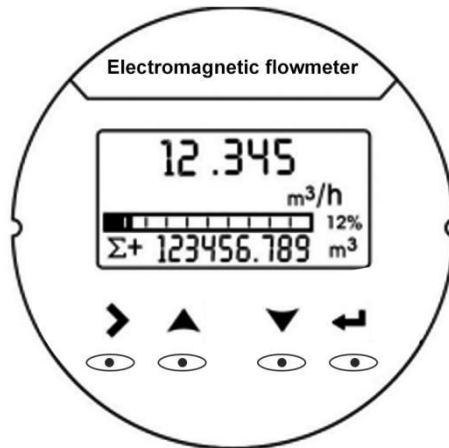

Figure 27

6.3. Display button operation instructions

Please open the converter cover before handling mechanical keys.

Press mechanical keys to enter configuration mode is shown in the next chapter.

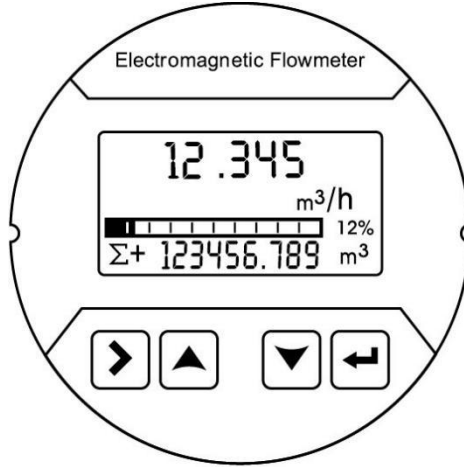



Figure 28

6.4. Quick setup menu

Key parameters to facilitate the manufacturer and user to quickly set up the meter:

Press on  and  at the same time to enter the parameter setting interface.

Enter the password.

Quickly set the password: 300000 (Used to modify the quick setup menu)

NO.	Parameter	Setting mode	Parameter range	Default
1	Sensor drift diameter	Option	3-2000	50
2	Flow range	Figure	0-99999	35.000
3	Sensor coefficient	Figure	0-99999	1.000
4	Zero correlation	Figure	0-99999	0.0
5	Accumulation reset	Option	Y、N	N
6	Flow remove	Figure	0-99%	1%
7	Time constant	Figure	0-99S	2s

6.5. Configuration details

NO.	Parameter	Setting mode	Password level	Parameter range	Default
1-Flow					
1-0	Flow range	Figure	User	0-99999	35.000
	Set the maximum flow limit value. Used to calculate the frequency, output current limit calculation and alarm threshold calculation, etc				
1-1	Flow unit	Option	User	L、m ³ 、Kg、t/s、min、h、gal/m、gal/h	m ³ /h
	Choose volume unit ,such as L, m ³ , gal; the density will not calculated; Choose mass unit such as Kg, t; need 1-2 density parameter.				
1-2	Fluid density	Figure	User	0.000-99.000	1.000
	Used to calculate the mass flow, $Q_M = \rho V_M$. When the flow unit is volume, this parameter are not displayed. Density unit: g/cm ³				
1-3	Time constant	Figure	User	0-99S	2s
	Damping coefficient of the filter, select the average selected within the time parameter as the real-time flow.				
1-4	Flow resection	Figure	User	0-10%	1%

	Flow volume is regarded as zero if it is below the setting value Zero means not removing.				
1-5	Flow direction	Option	User	Positive, Negative	Positive
	Used to change the direction of flow, when negative pole and positive pole signal cable are reversely connected, or the sensor is reversely installed, activate this function.				
1-6	Mode selection	Option	User	Positive, Negative	bidirection
	Set the direction of the flow measurement. Positive direction only measures forward direction measurement flow, negative direction only measures the reverse flow; bidirection indicates two-way flow measurement.				
1-7	Spike suppressor permission	Option	User	Y, N	N
	Indicate whether to enable peak inhibition function, used for filtering interference signals. When it's set to be N, 1-8, 1-9 configuration screens do not display. When the range of signal pulse is greater than parameters set in 1-8 and lasts for a duration less than that set in 1-9, the system will consider it as interference signal and will not display and measure .				
1-8	Peak inhibition coefficient	Figure	User	0.01-0.8m/s	0.8
	The peak amplitude (not shown when peak inhibition allows configuration closing)				
1-9	Peak inhibition time	Option	User	0-3s	1
	The peak amplitude (not shown when peak inhibition allows configuration closing)				
1-10	Flow correction permission	Option	Manufacturer	Y, N	N
	Indicates whether start using flow nonlinear correction function. In principle, used for small flow rate (less than 0.5 m/s) linear				

adjustment Designed with 4 sections of correction, divided into four flow points and four correction coefficients.

The corresponding velocity of correction point must meet:

Correction point 1 \geq Correction point 2 \geq Correction point 3 \geq Correction point 4 \geq 0

Correction calculation is conducted on the original sensor flow coefficient curve correction, therefore, the nonlinear correction function shall be disabled and sensor coefficient shall be marked. Then enable the nonlinear correction function according to the nonlinear of sensor and set correction coefficient for sectionized correction. If the coefficient is set right, there is no need for calibration. The original velocity stands for the actual flow velocity, and the revised flow velocity is called modified velocity, the modified computation formula is as follows:

At the interval of the modified point 1 $>$ The original flow velocity \geq The modified point 2

The modified flow velocity = Correction factor 1 \times The original flow velocity

At the interval of the modified point 2 $>$ The original flow velocity \geq The modified point 3

The modified flow velocity = Correction factor 2 \times The original flow velocity

At the interval of the modified point 3 $>$ The original flow velocity \geq The modified point 4

The modified flow velocity = Correction factor 3 \times The original flow velocity

At the interval of the modified point 4 $>$ The original flow velocity \geq 0

The modified flow velocity = Correction factor 4 \times The original flow velocity

Note: when set the modified point, shall keep the following relationship
Modified point 1 $>$ Modified point 2 $>$ Modified point 3 $>$ Modified point 4 $>$ 0

The intermediate value of correction coefficient is 1.0000, if the correction

	coefficient is greater than 1 , then increase the flow velocity ; if the correction coefficient is less than 1 , then decrease the flow velocity ;				
1-11	Flow correction point 1	Figure	Manufacturer	0.0-99.999	0
	Flow rate modified point 1, when The flow rate function shut down , this parameter does not display.				
1-12	Flow correction coefficient 1	Figure	Manufacture	0.0-99.999	1.000
	Flow rate correction factor 1, when The flow rate function is disabled, this parameter does not display.				
1-13	Flow correction point 2	Figure	Manufacturer	0.0-99.999	0
	Flow rate modified point 2, when The flow rate function is disabled, this parameter does not display.				
1-14	Flow correction coefficient 2	Figure	Manufacture	0.0-99.999	1.000
	Flow correction factor 2. This parameter is not displayed when the flow function is off.				
1-15	Flow correction coefficient 3	Figure	Manufacturer	0.0-99.999	0
	Flow rate modified point 3, when The flow rate function is disabled, this parameter does not display.				
1-16	Flow correction coefficient 3	Figure	Manufacturer	0.0-99.999	1.000
	Flow rate modified point 3, when The flow rate function is disabled, this parameter does not display.				
1-17	Flow correction coefficient 4	Figure	Manufacturer	0.0-99.999	0
	Flow rate modified point 4, when The flow rate function is disabled, this parameter does not display.				
1-18	Flow	Figure	Manufacturer	0.0-99.999	1.000

	correction coefficient 4				
	Flow rate modified point 4, when The flow rate function is disabled, this parameter does not display.				
2- Current output					
No.	Type	Option	Password level	Parameter range	Default
2-0	Reverse output permission	Option	User	Y, N	N
	When flow direction is reverse, whether 4-20 ma output is needed, pulse/frequency; cannot be disabled at positive flow.				
2-1	Adjust K	Figure	User	0-99999	1.000
	Used for adjusting the output current value, $I = Kx + B$				
2-2	Adjust B	Figure	User	0-99999	0.000
	Used for adjusting the output current value, $I = Kx + B$				
2-3	Output current	Display	User	4.00-20.00	--
	Display the current value(mA) of the current output				
3 - Pulse/frequency/alarm output					
3-0	Pulse output type	Option	User	Frequency, pulse, alarm	Frequency
	Frequency ,pulse equivalent/alarm output optional				
3-1	Transistor state	Option	User	High/low level	High level
	Select the level state of no frequency output, no pulse equivalent output, no alarm output				
3-2	Max. frequency	Figure	User	0-5000	2000
	Set the corresponding frequency of the real-time flow upper limit ; When selecting frequency output, this parameter displays.				
3-3	Pulse value (L/P)	Option	User	0.001-999.99 9	1.0
	Set the cumulant that each pulse stands for ;				

	When selecting equivalent output, this parameter displays.				
4 - Accumulation					
4-1	Accumulation clearance	Option	Manufacturer	Y, N	N
	Clear accumulation amount.				
4-2	Positive accumulation integer	Figure	Manufacturer	0-999999999	0
	Set total positive integer part				
4-3	Positive accumulation decimal	Figure	Manufacturer	0.0-0.999	0.0
	Set total positive decimal part				
4-4	Negative accumulation integer	Figure	Manufacturer	0-999999999	0
	Set reverse total integer part				
4-5	Negative accumulation decimal	Figure	Manufacturer	0.0-0.999	0.0
	Set reverse total decimal part				
5- Alarm contacts (3-0 set to show the configuration at alarm output)					
No.	Type	Option	Password level	Parameter range	Default
5-0	Alarm 1 transistor state	Option	User	High/Low lever	High level
	Touch spot outputs high and low level under no alarm state .				
5-1	Alarm1 output allowed	Option	User	Y/N	N
	Allow contact 1 output of main switch, when it's set to be N, the following parameters do not display.				
5-3	Allow alarm1 empty pipe	Option	User	Y/N	N

	Allow empty pipe alarm output switch. When the system detects empty pipe, contact 1 outputs alarm signal automatically. When the allowed alarm output configuration is N, this parameter does not display.				
5-4	Allowed alarm1 exceeds upper limit	Option	User	Y/N	N
	Allow flow rate upper limit alarm output switch. When the real-time flow is greater than the flow rate upper limit value, contact 1 outputs alarm signal automatically. See 7-1 for details. When allowed alarm output configuration is N, this parameter is not displayed.				
5-5	Allowed alarm1 exceeds lower limit	Option	User	Y/N	N
	Allow flow rate lower limit alarm output switch. When the real-time flow is smaller than the flow rate lower limit value, contact 1 outputs alarm signal automatically. See 7-2 for details. When allowed alarm output configuration is N, this parameter is not displayed.				
7- Alarm setup					
No.	Type	Option	Password level	Parameter range	Default
7-0	Max. flow value alarm	Figure	User	0-999.9%	100%
	Set the upper limit alarm value and range percentage.				
7-1	Min. flow value alarm	Figure	User	0-999.9%	0%
	Set the lower limit alarm value and range percentage.				
7-2	Alarm hysteresis	Figure	User	0-99.9%	1%
	Used to eliminate the alarm disturbance Upper limit elimination conditions: real-time flow is less than the upper limit alarm value minus return difference Lower limit elimination conditions: real-time flow is greater than the lower limit alarm value plus return difference				

7-3	Display alarm permission	Option	User	Y/N	N
	Allow alarm information to be displayed on the main screen				
8- System					
8-0	Language	Option	User	Chinese/ English	Chinese
	Set configuration display language				
8-1	Display accuracy	Figure	User	0-4	2
	The decimal digits of real-time volume.				
8-2	Contrast	Figure	User	0-100%	50%
	Contrast ratio of Liquid crystal display				
8-3	Modbus address	Figure	User	1-247	8
	Communication Protocol instrument address based on the RS485 protocol Modbus RTU				
8-4	Baud rate	Option	User	1200、2400、 4800、9600、 19200、 38400、 57600	9600
	Baud rate of serial communication of physical layer				
8-5	Even-odd check	Option	User	NONE/ODD/ EVEN	NONE
	Serial communication verification mode of physical layer				
8-6	Byte swap	Option	User	2-1 4-3、3-4 1-2、4-3 1-2、 1-2 3-4	2-1 4-3
	Byte exchange sequence of physical layer serial communication				
8-7	Device address	Figure	User	0-999999	000001
	HART device identification number				

8-8	User password	Figure	User	00000-99999 9	000000
	Used for check and modify parameter configuration; When the manufacturer's password is entered, this parameter is not displayed. Ex-factory password: 200000				
9-Empty Pipe parameters					
9-0	Empty pipe threshold value	Figure	Manufacturer	0-100%	50%
	Threshold for empty tube alarm judgment				
9-1	Actual electrical conductivity	Display	Manufacturer		
	Display the measured conductivity equivalent of the fluid. For general natural water: equivalent < 200 when the tube is full, equivalent > 1200 when the tube is empty (the equivalent is related to the fluid conductivity and the length of measuring line, it is recommended to use double shielded wire when the wiring distance is 20m , otherwise it will affect empty detection function.)				
9-2	Empty pipe check permission	Option	Manufacturer	Y, N	Y
	Set whether to enable empty detection function				
9-3	empty pipe check max	Figure	Manufacturer	0-9999	1200
	Measured conductivity equivalent value when the tube is empty, default values can be used for general natural water. It needs to observe whether the empty pipe for special fluid is that displayed as 9-1, then record it in 9-3.				
9-4	empty pipe check min	Figure	Manufacturer	0-9999	200
	Measured conductivity equivalent value when the tube is full, default values can be used for general natural water. It needs to observe whether the empty pipe for special fluid is that displayed as 9-1, then record it in 9-4.				
9-5	Empty pipe detection	Figure	Manufacturer	0-9999	30

	backlash				
	For the return difference judged by the empty pipe detection, the default value can be directly used within 20 meters of the signal line.				
10-Sensor					
10-0	Sensor coding	Figure/mark	Manufacturer	13 digitals	
	Used for identify sensors.				
10-1	Factory ID number	Figure	Manufacturer	6 digitals	
	Identification number				
10-2	diameter	Option	Manufacturer	3-2000	50
	Caliber of sensor				
10-3	Zero adjustment	Option	Manufacturer	-9.99-9.99mv	0.00mv
	Sensor code value under the condition of static and full pipe (mean value of 30 seconds) Under the circumstance of sensor symmetry and wiring is good (well shielded) and within the scope of code value + / - 0.1, no need to adjust.				
10-4	Sensor coefficient	Figure	Manufacturer	0-99999	
	The flowmeter coefficient was calibrated by the sensor manufacturer according to the actual flow volume. For details, see sensor coefficient calibration section				
10-5	Cali coefficient	Figure	Manufacturer		
	Ex-factory unification calibration coefficient of converter				
10-6	Zero correction	Figure	Manufacturer	0-99.999	
	For correcting the sensor's nonlinear correction for small flow (below 0.3 m/s) For details, see sensor coefficient calibration section.				
10-7	Excitation mode	Option	Manufacturer	3.125Hz、 6.25 Hz、12.5 Hz、25 Hz	6.25Hz
	Selection of excitation frequency 3.125Hz 、 6.25Hz、 12.5Hz、 25 Hz				

	Option 1: 3.125Hz Option 2: 6.25Hz				
10-9	Gain selection	Option	Manufacturer	2001/3/9	X3
	Gain selection: Adjustment of the gain can change the range of flow speed. Gain magnitude: 1, 3, 9				
11-Test parameters					
11-0	Allow test	Option	Manufacturer	Y/N	N
	Set to Y to make the test flow rate effective, and automatically return to N after power off.				
11-1	Flow rate	Option	Manufacturer	-99.999~99.999	1.000
	To set the simulated flow rate, it will take effect after setting "11-0 Allowed Test" to "Y".				
11-2	Source code	Option	Manufacturer	Y/N	N
	After set to Y, the original code of the signal will be displayed on the running screen, and this screen will display the firmware version number and product serial number at the same time				

6.6. Brief operating instruction and function

6.6.1. Parameter selection and adjustment

Press \triangleright and \triangleleft to enter into parameter setting interface.

Password need to be input by then

The initial user password: 200000 (used for modifying the user level parameter)

The initial manufacturer password: 100000 (used for modifying the manufacture level parameter)

The initial manufacturer password: 300000 (to set up parameter quickly)

After entering the configuration parameters, the parameters can be modified by the following operation:

Users can conduct the switch operation in the menu by pressing \triangleright and button, switch among the parameter item of menu by pressing the \triangleleft button and meanwhile store a modified parameter value. Adjust the parameter value by pressing \triangle and ∇ button. Such as flow upper limit.

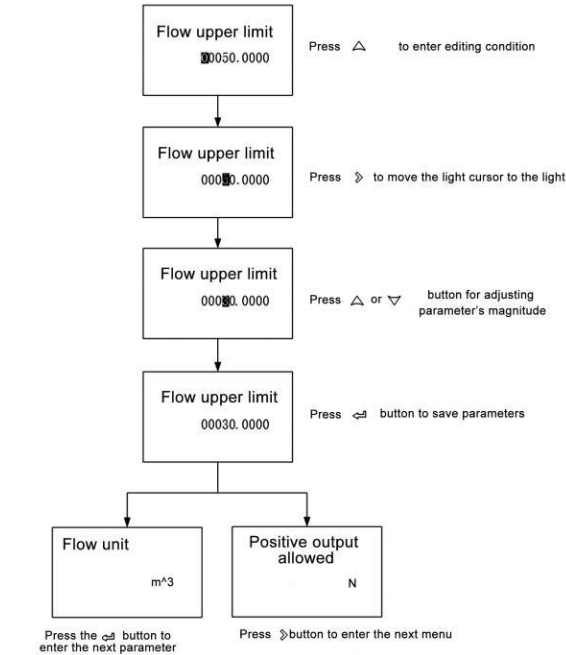

Figure 29

6.6.2. Display measurement

This picture will display after startup

$\Sigma+$: Forward cummulant , $\Sigma-$: Reverse cummulant, Σ :Net cummulant, V: Current flow velocity, MT: Conductivity equivalent

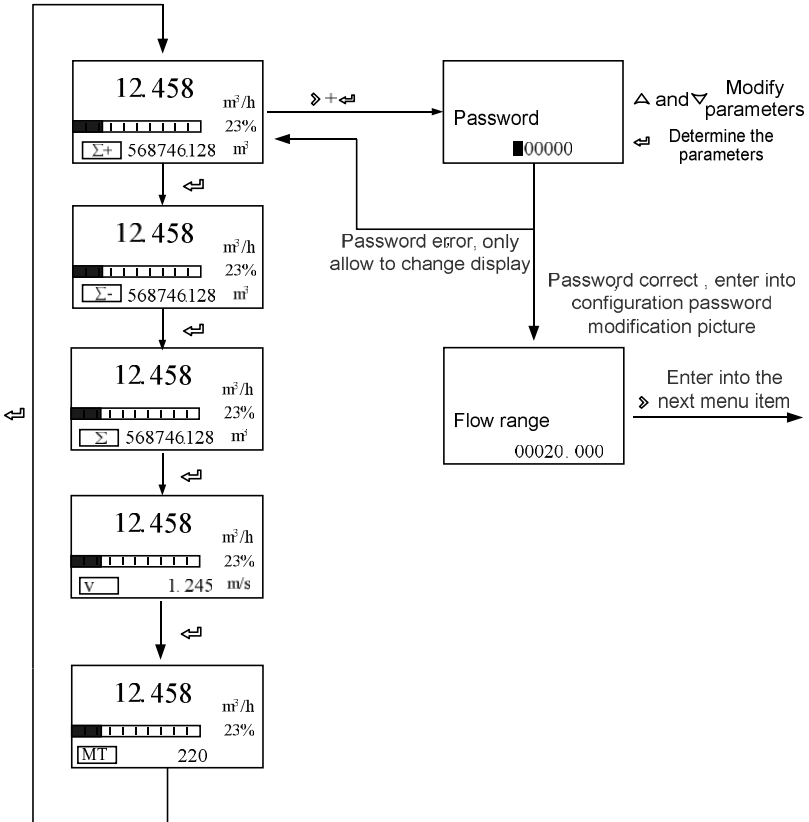

Figure 30

6.6.3. Flow setup and analog output menu

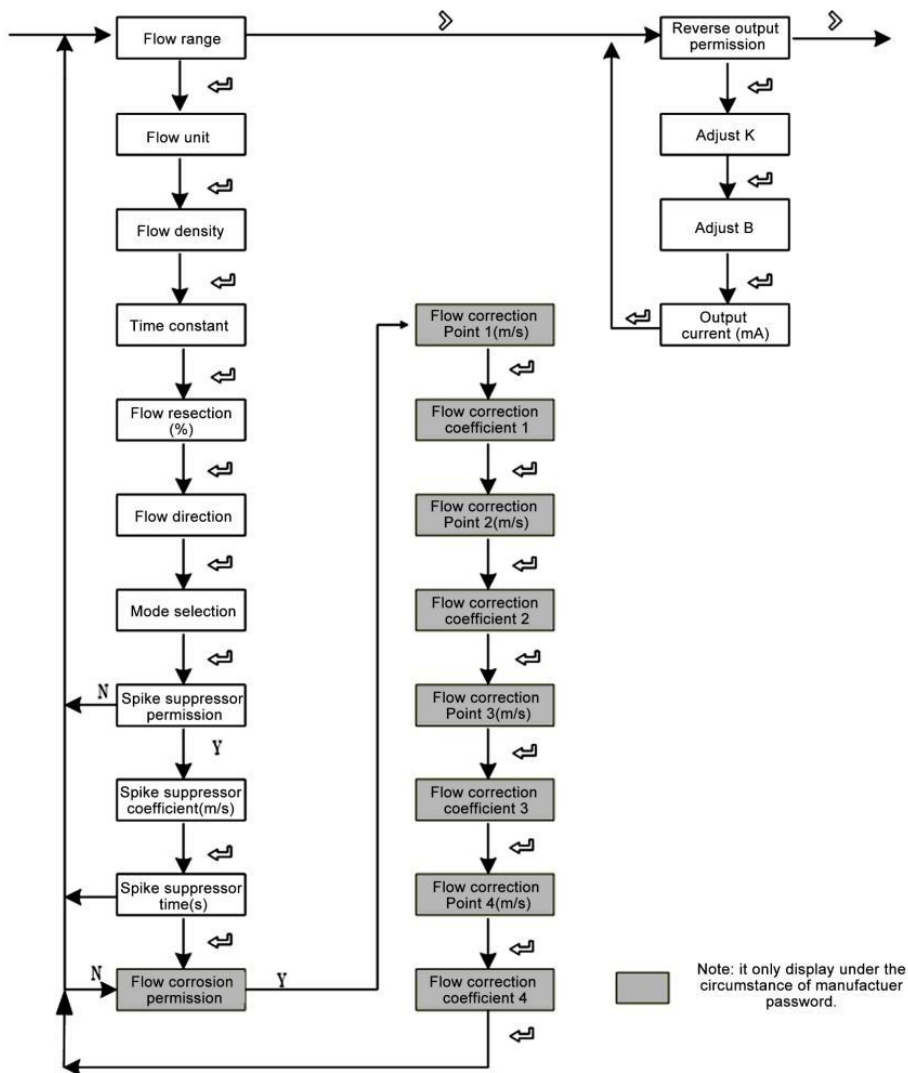

Figure 31

6.6.4. Pulse output and total set menu

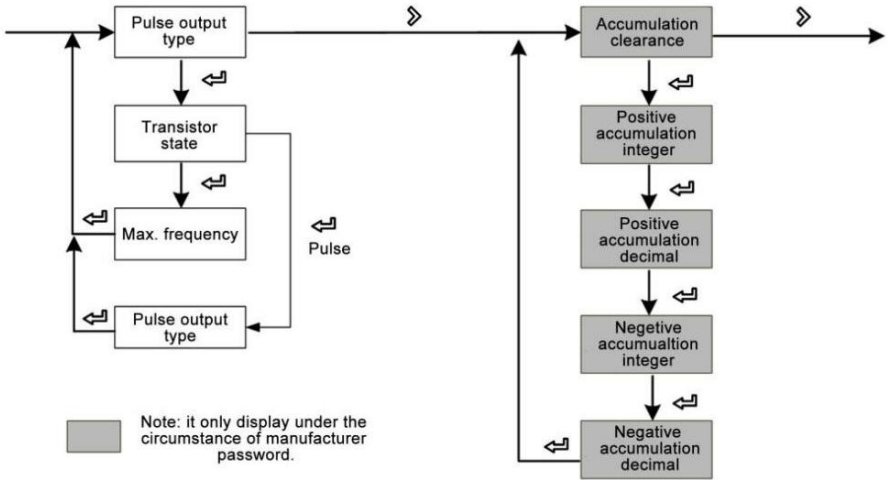

Figure 32

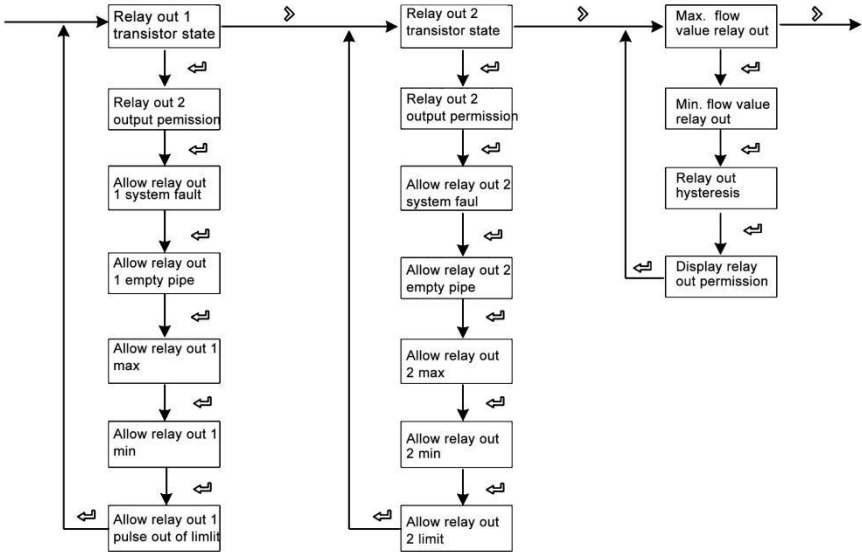

Figure 33

6.6.6. System function, empty pipe function, sensor function, test function setup menu

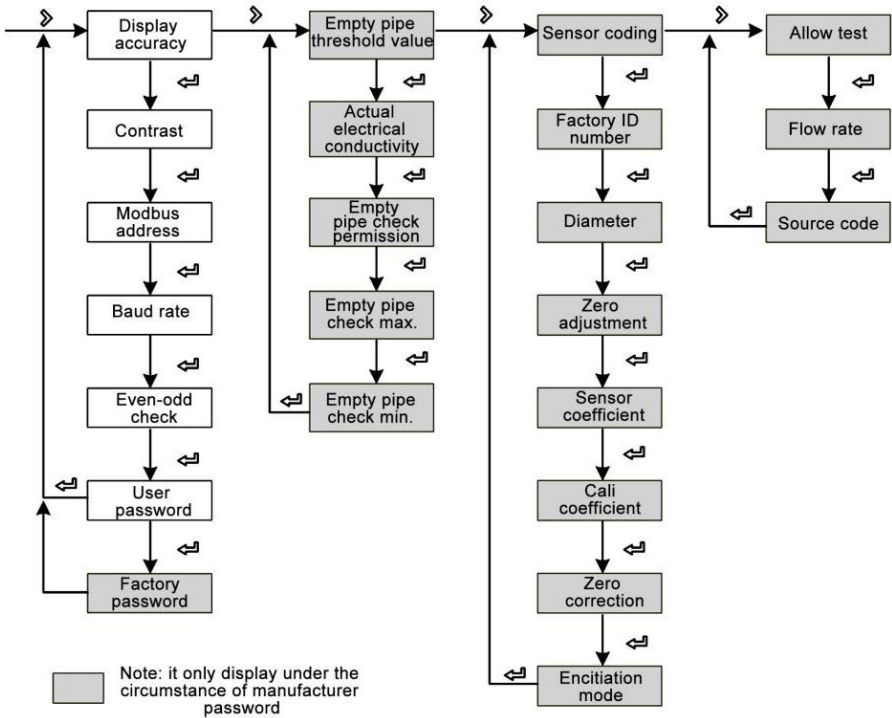

Figure 34

Chapter 7 Display Functions

7.1. System Information

Flowmeter itself has the self-diagnosis function, in addition to the power supply and circuit board hardware failures; it can correctly provide the corresponding alarm message to the fault in general application.

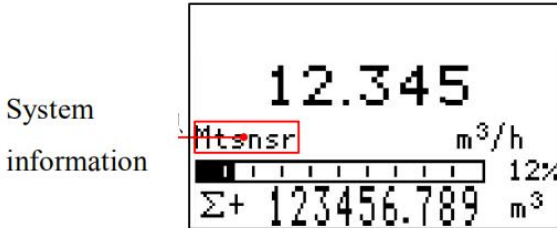

Figure 35 Display Position in Measuring Picture

System Information Sheet

Display	Alarm content
Mtsnsr	Sensor empty pipe
Hi	The current real-time flow rate exceeds the setting flow limit
Lo	The current real-time flow rate is below the setting flow lower limit
Pls	The pulse output frequency exceeds the setting frequency upper limit
AD_Hi	Sensor signal is greater than the AD sampling of the upper limit
Rng	The current real-time flow rate exceeds the setting flow limit
Rng_Hi	The current real-time flow rate exceeds system AD sampling limit
Pls_Hi	The range scope set by user exceeds the upper limit of pulse output.

7.2. Pulse/Frequency/Current Output

7.2.1. Pulse equivalent output

It is mainly used for sensor manufacturer coefficient calibration and user measurement use. In the third way configuration parameter Settings: Pulse equivalent corresponding accumulate indicate each pulse corresponding to the relevant volume number.

For example:

Parameter setting as 0.1L/p

The current real-time flow 3.6m³/h

Number of pulses per second output is : $3.6 \times 1000 / 3600 / 0.1 = 10$

Notes:

When the parameter is set to 0.4L/p

The current real-time flow is 3.6m³/h

Number of pulses per second output is: $3.6 \times 1000 / 3600 / 0.4 = 2.5$

If encounter the above situation, the decimal part of 2.5 pulses will automatically get into the next second output, data loss will not happen.

The pulse equivalent shouldn't be set too small when the pipe flow is small, otherwise it will cause pulse output exceeds the limit, then the main screen will appear PIs system alarm information. Users need to reset pulse equivalent parameters. Similarly, when the pipe flow is small the selected pulse equivalent cannot too big; otherwise it will cause the instrument to output a pulse for a long time, and further cause measurement error.

Pulse equivalent output is different from frequency output; pulse output will output a pulse when a pulse equivalent is accumulated enough, so the pulse output is uneven. Counter instrument should be used when measuring pulse output. Frequency meter instrument shouldn't be used.

7.2.2. Frequency Output

It is mainly used for manufacturer coefficient calibration and user measurement use. In the third group configuration parameters setting: frequency corresponds to real-time flow rate, upper frequency limit corresponds to max. flow rate.

Note: maximum frequency is set to 5000 Hz.

7.2.3. Current Output

Mainly used for transmitting output to other intelligent instruments, such as: digital display table, recorder, PLC, DCS, etc.

The current output type: 4 - 20mA.

The current valve corresponds to real-time flow rate, 20mA corresponds to range limit, 4 mA corresponds to range limit.

Conversion relationship

$$I_{\text{Real time}} = \frac{Q_{\text{Real time}}}{Q_{\text{max}}} 16.00 + 4.00$$

Notice:

$Q_{\text{real time}}$ Indicate real-time flow rate

Q_{Max} Indicate current instrument range

$I_{\text{real time}}$ Indicate real-time current value

7.3. Communication

This instrument provides a standard RS485 communication interface, using the international standard MODBUS-RTU communication protocol that supports 04 Read Holding Registers command.

7.3.1. Registered Address

Communication data and register address are in the following table.

Parameter	Type	Address	Explanation
Real-time flow rate	float	100	
Real-time flow velocity	float	102	
Flow percentage	float	104	50 stands for 50%
Electric conductivity	float	106	
Forward flow accumulation of integer	ulong	108	
Forward flow accumulation of decimal	ulong	110	The decimal part magnifies by 100 times, 123 stands for 0.123
Reverse flow accumulation of integer	ulong	112	
Reverse flow accumulation of decimal	ulong	114	The decimal part magnifies by 1,000 times 123 stands for 0.123

Note: Float/ulong/long type data, Communication transmission is in byte order 2-1-4-3; ushort type data transmission is in accordance with 2-1.

7.3.2. Communication Configuration

Mailing address: 1-247

Default address: 8

Baud rate: 1,200; 2,400; 4,800; 9,600; 19,200; 38,400; 57,600;

The default baud rate: 9600

Check: no check, odd parity, parity; Default no check;

For 32-bit data (long plastic or floating point) arranged in the communication frame;

Example: Long integer 16909060(01020304H): 03 04 01 02

Floating number 4.00(40800000H): 00 00 40 80

7.3.3. Readout Real-time Quantity Floating-point Communications

Example:

Real-time floating point number reading

Send message: 08 04 00 63 00 02 81 4C

Return message: 08 04 04 22 6E 41 3F 79 61(Real-time flow: 11.95)

Forward flow rate accumulate readout

Send message: 08 04 00 6B 00 04 80 8C

Return message: 08 04 08 00 6C 00 00 00 7B 00 00 D6 8E (The cumulative integer: 108, Cumulative decimal: 0.123, Accumulation: 108.123)

Chapter 8 Technical Parameters

8.1. Technical Parameters

Measuring System

Execution Standard	JB/T9248-2015	
Measuring principle	Faraday's law of electromagnetic induction	
Function	Real-time flow rate, flow velocity, mass flow (when the density is constant), real-time measurement and flow accumulation	
Module configuration	Measurement system is made up of signal converter and measurement sensor	
Converter		
Compact Type	IP65	
Remote Type	IP65(IP68 optional)	
Measurement sensor		
Nominal Diameter	DN15-DN1000	
Flange	In line with GB/T9119-2000 standard carbon steel (Optional stainless steel flanges), other standard flange can be customized	
Pressure rating (High pressure can be customized)	DN6 - DN80, PN<4.0MPa	
	DN100 - DN150, PN<1.6MPa	
	DN200 - DN1000, PN<1.0MPa	
	DN1200 - DN2000, PN<0.6MPa	
Lining Material	Chloroprene rubber (CR), Polytetrafluoroethylene (PTFE/F4), Fluorinated ethylene propylene (FEP/F46), Teflon(PFA)	
Electrode Material	316L Stainless Steel, Hastelloy C, Hastelloy B, Ti, Ta, Pt	
IP Rate	IP68	IP65
Medium temperature	-25 - 180℃	-10 - 80℃
Buried depth	Less than 5 meters (only IP68 protection of remote type sensor)	
Immersion depth	Less than 3 meters (only IP68 protection of remote type sensor)	
Sensor cable	Only for remote type, the standard 10m cable; other cables suggest custom no longer than 20 meters.	

Communications

Serial communications	RS-485
Output	Current (4-20 mA) , pulse , frequency , state switch
Function	ATC recognition, electrode contamination

Display User Interface

Graphic display	Monochrome LCD, white backlight; Size: 128*64 pixels
Display function	2 measurement value pictures (measurements, condition, etc)
Language	Chinese/ English
Unit	You can configure the menu to select the unit Refer to "6.5 Configuration details" --- "flow units 1-1"
Operating unit	4 Mechanical keys (Compact Type) or 4 touch key (Remote Type)

Measurement Accuracy

Max measuring error	Measurement value $\pm 0.5\%$ (Flow speed $> 1\text{m/s}$) ; Measurement value $\pm 0.5\% \pm 2\text{mm/s}$ (Flow speed $< 1\text{m/s}$)
Repetitiveness	0.15%
Temperature sensor measuring range	$-20^{\circ}\text{C} \sim 120^{\circ}\text{C}$
Maximum measurement error	$\pm 0.1^{\circ}\text{C}$ (Within the measuring range of temperature sensor)

Operating Environment

Temperature	
Environment	$-10^{\circ}\text{C} - 55^{\circ}\text{C}$ for Compact-Type Flowmeter $-10^{\circ}\text{C} - 60^{\circ}\text{C}$ for Converter of Remote-Type Flowmeter $-10^{\circ}\text{C} - 55^{\circ}\text{C}$ for Converter of Remote-Type Flowmeter
Storage	$-40^{\circ}\text{C} - 65^{\circ}\text{C}$

Electric Conductivity

Water	Min. 20 μ S/cm (Actual electric conductivity should be greater than 50 μ S/cm)
Other	Min. 5 μ S/cm (Actual electric conductivity should be greater than 50 μ S/cm)

Material

Sensor housing	Carbon steel
Converter	Standard die cast aluminum

Electrical Connections

Power supply	100-240VAC, 50/60Hz, 22VDC—26VDC
Power consumption	Max 15VA
Signal cable	Apply only to remote type
Shielded cable	Signal section, wire: 0.5mm ² Cu /AWG20

Output

Current output		
function	Measurement of volume and quality (in the case of constant density)	
Setting	scope	4-20mA
	Max	20mA
	Min	4mA
Internal voltage	24VDC	
loading	$\leq 750\Omega$	
Pulse and frequency output		
function	Set up Pulse and frequency output	
Pulse output	basis	Output pulse width: 0.25ms ~100ms Duty cycle: 50% (Pulse frequency ≥ 5 Hz) Fmax \leq 5000 cp/s
	setting	0.001L – 1m ³
frequency	Max	Fmax \leq 5000Hz
	setting	0-5000Hz
passive	U _{Outer} \leq 36VDC	
Status output		
function	Output as alarm	
passive	U _{Outer} \leq 36VDC	

8.2. Electrode selection and specification

Corrosion Resistance of Electrode Material (Only for Reference)

Material	Corrosion Resistance
Molybdenum-containing stainless steel (0Cr18N12Mo2Ti)	Applicable: Domestic/industrial water, sewage, weak acid and alkali saline as well as concentrated nitric acid at room temperature. Not Applicable : Hydrofluoric acid, hydrochloric acid, chlorine, bromine, iodine and other media.
Hastelloy B	Applicable: Non-oxidizing acid, such as hydrochloric acid and hydrofluoric acid of certain concentration and other alkali liquor with a concentration of no less than 70% sodium hydroxide Not Applicable: Nitric acid and other oxidizing acids
Hastelloy C	Applicable: corrosion by oxidizing acids such as Nitric acid, acid mixtures and sulfuric acid and environmental corrosion by oxidation resistant salt or that contains other oxidants. For example, Hypochlorite solution higher than room temperature is strongly corrosion resistant to sea water. Not Applicable: Reducing acid and chloride such as hydrochloric acid
Ti	Applicable: chloride, hypochlorite, sea water, oxidizing acid. Not applicable: reducing acid such as hydrochloric acid, sulphuric acid
Ta	Applicable: most acids like concentrated hydrochloric acid, nitric acid and sulfuric acid including hydrochloric acid and nitric acid at the boiling point as well as sulfuric acid under 175 °C. Not applicable: alkali, hydrofluoric acid and smoke sulfuric acid.
Pt	Various acids, bases and salts, excluding aqua regia.

Notes: Due to a wide variety of media, their corrosive substance is affected by complex factors such as temperature, concentration and tassel.

So this table is only for reference. Users may make their own choices based on actual situation. You may refer to corrosion prevention manual for general media.

But for media with complex compositions like mixed acid, you may need to conduct corrosion tests for materials to be selected.

8.3. Flowmeter

Flowmeter

Nominal Diameter (mm)	Flow range (m ³ /h)		
	10	0.02827-0.25	0.3-1.6
15	0.0636-0.6	0.8-3.0	4.0-7.632
20	0.131-1.0	1.2-5.0	6.0-13.6
25	0.176-1.6	2.0-8.0	10-21
32	0.2895-2.5	3.0-12	16-35
40	0.4524-4.0	5.0-20	25-45
50	0.707-6.0	8.0-40	50-85
65	1.195-10	12-60	80-143
80	1.81-16	20-120	160-217
100	2.83-25	30-160	200-339
125	4.42-40	50-250	300-530
150	6.36-60	80-400	500-763
200	11.3-100	120-600	800-1357
250	17.7-160	200-800	1000-2120
300	25.45-250	300-1200	1600-3054
350	34.6-300	400-1600	2000-4157
400	45.2-400	500-2000	2500-5429
450	57.3-500	600-2500	3000-6871
500	70.7-600	800-3000	4000-8482
600	102-800	1000-4000	5000-12216
700	139-1200	1600-5000	6000-16620
800	181-1600	2000-6000	8000-21720
900	229-1600	2000-8000	10000-27480
1000	283-2000	2500-10000	12000-33924
1200	407-2500	3000-12000	16000-48833
1400	554-3000	4000-16000	20000-66468
1600	723-4000	5000-20000	27000-86815

Reduction formula: (Flow) Q = (flow velocity) V × π × (DN/2)², Unit: m/s and m³/h

8.4. Flow and Velocity Parallel Table for Electromagnetic Flowmeter

DN (mm)	Flow (m/s)	0.1	0.2	0.4	0.5	1	10	12	15
	Flow (m ³ /h)								
DN10		0.02827	0.0565	0.1131	0.1414	0.2827	2.827	3.39	4.24
DN15		0.0636	0.127	0.25	0.318	0.636	6.362	7.632	9.54
DN20		0.131	0.226	0.45	0.566	1.131	11.31	13.572	16.965
DN25		0.176	0.35	0.71	0.8835	1.767	17.67	21.204	26.505
DN32		0.2895	0.58	1.16	1.448	2.895	28.95	34.74	43.425
DN40		0.4525	0.90	1.81	2.62	4.524	45.24	54.208	67.86
DN50		0.707	1.414	2.83	3.535	7.069	70.69	84.83	106
DN65		1.195	2.39	4.78	5.973	11.946	119.5	143.35	179.2
DN80		1.81	3.62	7.24	9.048	18.1	181	217.2	271.5
DN100		2.83	5.65	11.31	14.14	28.27	282.7	339.24	424.05
DN125		4.42	8.84	17.67	22.09	44.18	441.8	530.16	662.7
DN150		6.36	12.7	25.5	31.81	63.62	636.2	763.44	954.3
DN200		11.3	22.6	45.2	45.55	113.1	1131	1357.2	1696.5
DN250		17.7	35.4	70.7	88.36	176.7	1767	2110.4	2650.5
DN300		25.45	51	102	127.24	254.5	2545	3054	3878.5
DN350		34.64	69	139	173.2	356.4	3464	4156.8	5196
DN400		45.24	90	181	226.2	452.4	4524	5428.8	6786
DN450		57.3	114	229	286.3	572.6	5726	6871.2	8589
DN500		70.7	141	283	353.4	706.9	7069	8484.8	10603.5
DN600		102	203	407	508.9	1018	10179	12216	15270
DN700		139	277	554	692.7	1385	13854	16620	20775
DN800		181.0	362	723	905	1810	18096	21720	27150
DN900		229.0	458	916	1145	2290	22902	27480	34350
DN1000		283	565	1131	1414	2827	28274	33924	42405
DN1200		407	814	1628	2034.7	4069.4	40694	48832.8	61041
DN1400		554	1108	2216	2769.5	5539.4	55390	66468	83085
DN1600		723	1447	2894	3617.3	7234.6	72346	86815.2	108519

8.5. Accuracy

Reference condition

- (1) Medium: water
- (2) Temperature: 20°C
- (3) Pressure: 0.1MPa
- (4) Front straight conduit: $\geq 5DN$, Rear straight conduit: $\geq 2DN$

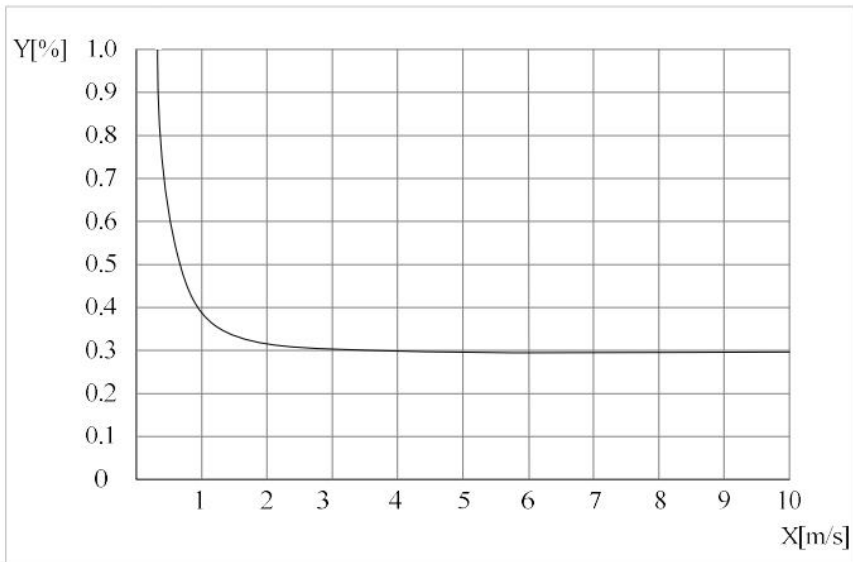

Figure 36

- ① X[m/s]: Flow rate
- ② Y[%]: Actual measured value deviation (mV)

Chapter 9 Plug-in type electromagnetic flowmeter series

9.1. The functional use and scope of application of the product

The plug-in electromagnetic flow sensor (sensor for short) and electromagnetic flow converter (converter for short) are matched to form a plug-in electromagnetic flowmeter (flowmeter for short) for measuring the volume flow of various conductive liquids in the conveying pipeline.

The sensor has the following characteristics

- (1) There are no moving parts in the sensor, which is simple in structure and reliable in operation.
- (2) The plug-in structure can be easily installed and disassembled without stopping water under low pressure or under pressure. Therefore, it is very suitable for the fluid measurement of existing pipelines and is convenient for the maintenance and repair of instruments.
- (3) The measurement accuracy is not affected by changes in physical parameters such as temperature, pressure, density, viscosity, conductivity (as long as the conductivity is greater than 5) of the measured medium.
- (4) The sensor has almost no pressure loss and very low energy loss.
- (5) Compared with the ordinary electromagnetic flowmeter, the manufacturing cost and installation cost are lower and is particularly suitable for flow measurement of large and medium diameter pipeline.
- (6) Adopt advanced low frequency square wave excitation. Zero stability, strong anti-interference ability and reliable work.
- (7) The flow measurement range is large. The full-scale flow rate in the pipeline under test can be arbitrarily set from 1m / s to 10m / s, and the output signal has a linear relationship with the flow rate.
- (8) The flowmeter is not limited to 0~10mA(DC) or 4~20mA (DC) standard current output and 1 ~ 5kHz frequency output at the same time.

Because the flowmeter (sensor) has the above-mentioned advantages, it has

been widely used in industrial sections such as chemical industry, chemical fiber, metallurgy, chemical fertilizer, paper making, water supply and drainage, sewage treatment, etc. and in automatic control of the production process.

9.2. Product form and composition

The product type is magnetic insertion. It is connected with the pipeline through a mounting base, a ball valve, a compression nut and a positioning screw. Sensor measurement can be divided into two types of structure: measurement tube type and plane electrode type. The measuring tube type sensor is suitable for measuring the cleaning medium; the planar electrode type is suitable for measuring the liquid flow rate containing other impurities in the medium.

9.3. Main technical specification

- (1) Applicable pipe diameter:
200~2000mm
- (2) Flow rate measurement range:
0~1 to 0~10m/s, the full scale is continuously adjustable in the range of 1~10m/s.
- (3) Measurement accuracy:
When the full-scale flow rate is 1 m/s, the accuracy is $\pm 2.5\%$.
- (4) Conductivity of the measured medium: $> 50\mu\text{S/cm}$
- (5) Working pressure: 1.6Mpa
- (6) Electrode material:
Molybdenum-containing stainless steel 0Cr118Ni12Mo2Ti, Hastelloy c-276, titanium Ti, and the like.
- (7) Measuring tube (measuring head) material: ABS
- (8) The highest temperature of the measured medium: ABS60℃
- (9) Shell protection level: It complies with the relevant provisions of IP68 of GB-08-84 standard.
- (10) Sensor output signal: 0.209mVp-p/1m/s.
- (11) The maximum transmission distance between the sensor and the converter is

50m (please contact the factory for special requirements)

- (12) Flowmeter output signal: DC current: 0~10mA, load resistance is 0~1k Ω
4~20mA, load resistance is 0~500 Ω
Frequency: 1~5KHz, load resistance is 250~1.2k Ω

9.4. Structure

The sensor is mainly composed of a measuring head (or measuring tube), an excitation system, an insertion rod, a junction box, a mounting base, and a bee positioning mechanism.

Measuring head (or measuring tube): The measuring head (measuring tube) is located at the particle of the measured flow velocity in the pipeline and is used to detect the flow velocity at this point. The measuring head (or measuring tube) consists of an end or conduit made of insulating material, on which a pair of electrodes is mounted. Except for the electrode tip or the inner wall of the measuring tube, the other parts are insulated from the fluid to be measured.

Excitation system: The excitation system is used to generate a working magnetic field. It consists of excitation coil and iron core. It is insulated and sealed into the insertion rod.

Insertion rod: made of stainless steel material. The east measuring tube of the measuring head is fixed in the insertion rod. The excitation lead and the electrode lead are sealed with the medium to be tested by the insertion rod and connected to the junction box. The insertion rod is welded with a direction indicator rod to ensure that the working magnetic field, the flow rate and the electrode connection line are perpendicular to each other during installation, and meet the requirements of Faraday's law of electromagnetic induction.

Terminal box: The junction box is located on the top of the sensor. The terminals in the junction box act as a connection between the sensor and the converter.

Mounting base: the mounting base is welded to the pipeline under test and is used to connect with the mounting ball valve and insert the electromagnetic flowmeter sensor.

Sealing mechanism: composed of pressing screw seat, pressing nut, rubber washer and set screw made of stainless steel material. It is used to seal and insert the electromagnetic sensor so that it can withstand a certain working pressure.