

pH/ORP Controller

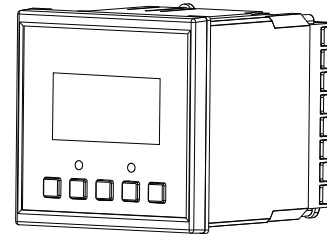

Supmea

Headquarters

5th floor, Building 4, Singapore Hangzhou Science Technology Park, No. 6 street, Hangzhou Economic Development Area, Hangzhou 310018, China

Singapore

2 Venture Drive #11-30 Vision Exchange Singapore

✉ info@supmea.com

🌐 www.supmea.com

Supmea Automation Co., Ltd.

Preface

Thank you for purchasing pH/ORP controller. Please read this manual carefully before operating and using it correctly to avoid unnecessary losses caused by false operation.

Note

- Modification of this manual's contents will not be notified as a result of some factors, such as function upgrading.
- We try our best to guarantee that the manual content is accurate, if you find something wrong or incorrect, please contact us.
- This product is forbidden to use in explosion-proof occasions.

Version

U-SUP-PH163S-EN1

Safety Precautions

In order to use this product safely, be sure to follow the safety precautions described.

About this manual

- Please submit this manual to the operator for reading.
- Please read the operation manual carefully before applying the instrument. On the precondition of full understanding.

This manual only describes the functions of the product. The company does not guarantee that the product will be suitable for a particular use by the user.

Precautions for protection, safety and modification of this product

- To ensure safe use of this product and the systems it controls, Please read carefully the operation manual and understand the correct application methods before putting into operation, to avoid unnecessary losses due to operation mistakes. If the instrument is operated in other ways not described in the manual, the protections that the instrument give may be destroyed, and the failures and accidents incurred due to violation of precautions shall not be borne by our company.
- When installing lightning protection devices for this product and its control system, or designing and installing separate safety protection circuits for this product and its control system, it needs to be implemented by other devices.

-
- If you need to replace parts of the product, please use the model specifications specified by the company.
 - This product is not intended for use in systems that are directly related to personal safety. Such as nuclear power equipment, equipment using radioactivity, railway systems, aviation equipment, marine equipment, aviation equipment and medical equipment. If applied, it is the responsibility of the user to use additional equipment or systems to ensure personal safety.
 - Do not modify this product.
 - The following safety signs are used in this manual:



Hazard, if not taken with appropriate precautions, will result in serious personal injury, product damage or major property damage.



Warning: Pay special attention to the important information linked to product or particular part in the operation manual.



- Confirm if the supply voltage is in consistent with the rated voltage before operation.
- Don't use the instrument in a flammable and combustible or steam area.
- To prevent from electric shock, operation mistake, a good

grounding protection must be made.

- Thunder prevention engineering facilities must be well managed: the shared grounding network shall be grounded at is-electric level, shielded, wires shall be located rationally, SPD surge protector shall be applied properly.
- Some inner parts may carry high voltage. Do not open the square panel in the front except our company personnel or maintenance personnel acknowledged by our company, to avoid electric shock.
- Cut off electric powers before making any checks, to avoid electric shock.
- Check the condition of the terminal screws regularly. If it is loose, please tighten it before use.
- It is not allowed to disassemble, process, modify or repair the product without authorization, otherwise it may cause abnormal operation, electric shock or fire accident.
- Wipe the product with a dry cotton cloth. Do not use alcohol, benzine or other organic solvents. Prevent all kinds of liquid from splashing on the product. If the product falls into the water, please cut off the power immediately, otherwise there will be leakage, electric shock or even a fire accident.
- Please check the grounding protection status regularly. Do not operate if you think that the protection measures such as grounding protection and fuses are not perfect.
- Ventilation holes on the product housing must be kept

clear to avoid malfunctions due to high temperatures, abnormal operation, shortened life and fire.

- Please strictly follow the instructions in this manual, otherwise the product's protective device may be damaged.



- Don't use the instrument if it is found damaged or deformed at opening of package.
- Prevent dust, wire end, iron fines or other objects from entering the instrument during installation, otherwise, it will cause abnormal movement or failure.
- During operation, to modify configuration, signal output, startup, stop, operation safety shall be fully considered. Operation mistakes may lead to failure and even destruction of the instrument and controlled equipment.
- Each part of the instrument has a certain lifetime, which must be maintained and repaired on a regular basis for long-time use.
- The product shall be scrapped as industrial wastes, to prevent environment pollution.
- When not using this product, be sure to turn off the power switch.
- If you find smoke from the product, smell odor, abnormal noise, etc., please turn off the power immediately and contact the company in time.

Disclaimer

- The company does not make any guarantees for the terms outside the scope of this product warranty.
- This company is not responsible for damage to the instrument or loss of parts or unpredictable damage caused directly or indirectly by improper operation of the user.

Package contents

Number	Name	Quantity	Remarks
1	pH/ORP Controller	1	
2	Manual	1	
3	Certificate	1	

Package contents

After opening the box, please confirm the package contents before starting the operation. If you find that the model and quantity are incorrect or there is physical damage in appearance, please contact us.

Contents

Chapter1 Introduction	1
1.1. Characteristics	1
1.2. Parameters	2
Chapter2 Installation	4
2.1. Instrument installation	4
2.2. Electrode installation	7
2.3. Wiring	8
Chapter3 Navigation keys	10
Chapter4 System menu & operating	11
4.1. Monitoring page	11
4.2. Alarm inquiry page	11
4.3. Password verification page	12
4.4. Main menu	12
Chapter5 Setting	13
5.1. Calibration	13
5.2. Setup	17
5.3. System	20
5.4. Maintenance	22

Chapter6 Maintenance	23
Chapter7 Troubleshooting	25
Chapter8 Communication	27
Chapter9 Warranty & After-sales Service	29

Chapter1 Introduction

This product is an instrument developed by our company for online monitoring of pH / ORP value. The data can be transmitted to the monitoring room through RS485 or 4-20mA.

The pH / ORP controller is widely used in thermal power, chemical fertilizer, metallurgy, environmental protection, pharmaceutical, biochemical, food, tap water and other industries, and it continuously monitors the pH or ORP value and temperature in the solution.

Continuous monitoring data is connected to the recorder through the transmission output to achieve remote monitoring and recording.

1.1. Characteristics

- Modular design
- Isolated transmission output, less interference
- Isolated RS485 communication
- Measure pH / ORP and temperature
- Manually/ automatically temperature compensation
- High and low alarm
- Alarm switch

1.2. Parameters

Table 1

Screen size	2.8 inch monochrome LCD, Resolution:128*64
Dimension	Overall dimension: 96mm×96mm×113mm
	Cutout dimension: 92mm×92mm
Weight	0.5kg
Variables	pH/ORP
Measure range	pH: 0.00pH~14.00pH
	ORP: -2000mV~2000mV
Accuracy	pH: ± 0.02 pH; ORP: (-2000 ~ -1000)mV, ± 2 mV (-1000 ~ 1000)mV, ± 1 mV (1000 ~ 2000)mV, ± 2 mV
Input resistance	$\geq 10^{12}\Omega$
Temperature compensation	NTC10K: -10°C~60°C Accuracy $\pm 0.3^\circ\text{C}$ 60°C~130°C Accuracy $\pm 2^\circ\text{C}$
	Range: -10°C~130°C Manual/Auto
Current output	Isolated, 4mA ~ 20mA can be set corresponding to pH / ORP measurement range, maximum loop is 750 Ω , $\pm 0.2\%$ FS
Alarm	2 channels, Pickup/Breakaway AC250V/3A
Relative humidity	10%RH ~85%RH (no condensation)

Working temperature	0°C~60°C
Power supply	AC: 220V±10%, 50Hz;
	DC: 24V
Power consumption	≤5W
Storage	Temperature: -10°C~60°C Relative humidity: 5%~85% (no condensation) Altitude: <2000m

Chapter2 Installation

2.1. Instrument installation

The installation location and installation method of this product are explained. Please be sure to read this section when installing.

Installation precautions

- The instrument is panel mounted.
- Please install it at the place with good ventilation in order to prevent the internal temperature of the instrument from rising.
- Horizontal installation shall be realized as possible

The following places shall be avoided during the installation

- Do not expose direct to sunlight and near heaters.
- The location where the environment temperature exceeds 60°C during the work.
- The location where the environment humidity exceeds 85% during the work.
- The vicinity of the electromagnetic occurring sources.
- The sites with strong mechanical vibration.
- The site where the temperature is changed a lot and the moisture condensation is easily formed.
- Places with lots of lampblack, steam, moisture, dust and corrosive gas.

Installation method:

Open a 92mm × 92mm mounting hole in the product cabinet or mounting panel, the thickness of the mounting panel is 1.5mm~13mm

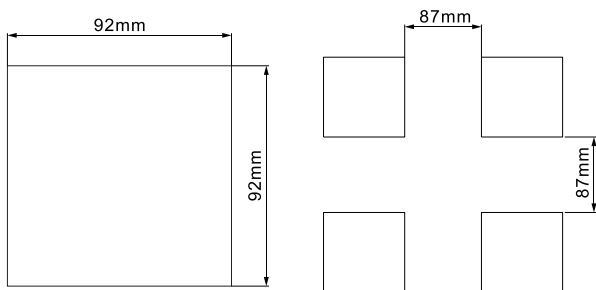

Figure 1 Mounting hole dimension drawing

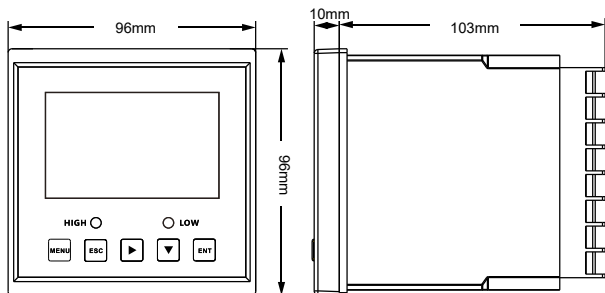

Figure 2 Dimension

Insert the product into the mounting hole fixing screw, as shown in Figure 3:

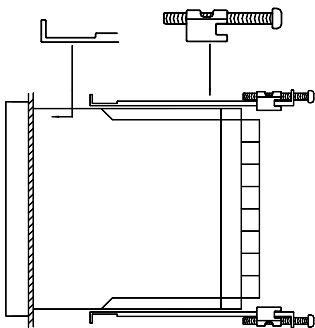

Figure 3 Installation

2.2. Electrode installation

- Schematic diagram of common installation methods

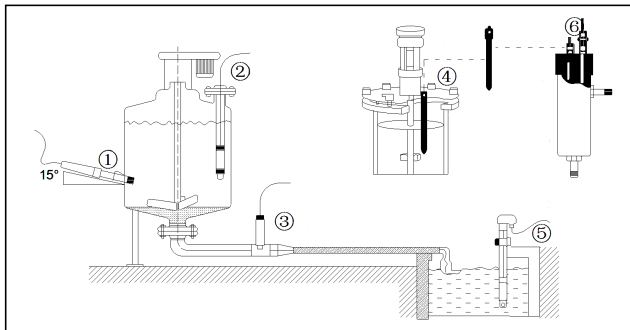

Figure 4 common installation methods

- ① Side wall installation
- ② Flange mounted at the top
- ③ Pipe installation
- ④ Top installation
- ⑤ Submersible installation
- ⑥ Flow-through installation

The interface must be in 15 oblique angle, or it will affect the normal test and use of the electrode. We won't be responsible for any results due to this.

2.3. Wiring

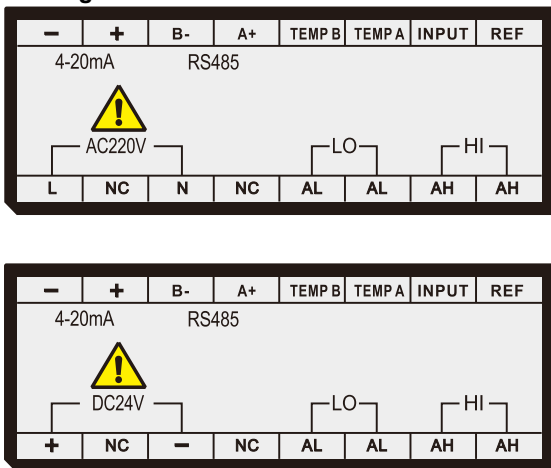

Figure 5

Identification of terminal

- REF: Reference terminal of the electrode
- INPUT: Measuring terminal of the electrode
- TEMP A: Temperature compensation A
- TEMP B: Temperature compensation B
- RS485 A+: RS485 communication interface A+
- RS485 B-: RS485 communication interface B-
- NC: Unidentified
- 4~20mA+: 4~20mA output +

- 4~20mA-: 4~20mA output -
- AC220V(L): AC220V live wire
- AC220V(N): AC220V neutral wire
- LO(AL): Low alarm relay
- HI(AH): High alarm relay
- DC24V+: DC24V +
- DC24V-: DC24V -

Chapter3 Navigation keys

Button display

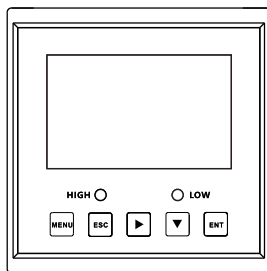







Figure 6

Definition

Table 2

Sign	Button name	Key function
	Menu	Under "Monitoring page" - Enter the MENU Under "Menu page" - Exit the MENU
	Escape	Under "Monitoring page" - Alarm view Under "Menu page" - Return to the previous page Under "Calibration page" - Skip this item
	MOVE RIGHT	Make a recurrent selection of digit of parameters modify the original indication value
	MOVE DOWN	Under "menu page" - Select the related menu Modify the values in the configuration state
	ENTER	Under "Menu page" - Enter the sub-menu or confirm modification

Chapter4 System menu & operating

4.1. Monitoring page

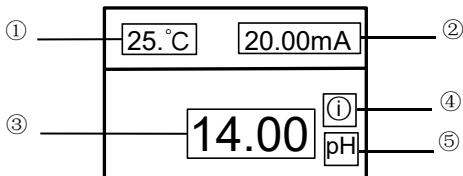

Figure 7

- ①:Temperature
- ②:Output current
- ③:Measured value
- ④:Fixed output
- ⑤:Unit

4.2. Alarm inquiry page

Push [ESC] to enter alarm inquiry page, to inquire the current warning configuration information

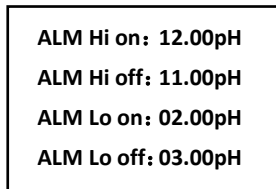

Figure 8

4.3. Password verification page

Push [MENU] to enter password verification page;

-----User Password-----

Password: 0000

Figure 9

- Input password and push [ENTER] to enter home page.
- Initial password is 0000, which can be modified via password modification function.
- Please contact us if you forget your password.

4.4. Main menu

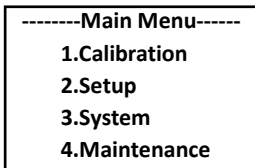

Figure 10

Calibration: Sensor calibration, temperature offset, calibration parameters and historical parameters.

Setup: Sensor type, temperature compensation, communication, analog output, alarm and damping time setting.

System: Language, buzzer, password modification, factory setting and information query.

Maintenance: Fixed output state setting.

Chapter5 Setting

5.1. Calibration

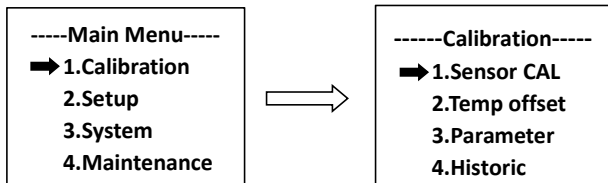

Figure 11

(1) Sensor calibration

- pH calibration

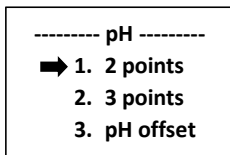

Figure 12

2 points calibration : Select two corresponding standard solutions according to the acid-base condition of the test solution.

- ① Clean the electrode with distilled water and dry the water stains.
- ② Put the pH electrode in the 6.86pH/7.00pH standard solution and let it stand for a while. After the displayed value is stable, press the [ENT] button;
- ③ Wash the electrode with distilled water and dry the water stains.

- ④ Put the pH electrode into the 4.00pH/4.01pH (acidic) or 9.18pH/10.01pH (alkaline) standard solution, and let it stand for a while. After the displayed value is stable, press the [ENT] button.
- ⑤ After the calibration is successful, The pH calibration process ends.

3 points calibration :

- ① After entering the pH calibration interface, first put the pH electrode into the 4.00pH/4.01pH standard solution and let it stand for a while. After the displayed value is stable, press the [ENT] button;
- ② Wash the electrode with distilled water and dry the water Then put the pH electrode into the 6.86pH/7.00pH standard solution, let it stand for a while, and press the [ENT] button after the displayed value is stable;
- ③ Wash the electrode with distilled water, dry the water stains, and finally put the pH electrode into 9.18pH /10.01pH standard solution, let it stand for a while, after the displayed value is stable, press the [ENT] button.
- ④ After the calibration is displayed successfully, the pH calibration process is over.

pH offset :

Use a buffer solution or directly use sample water for measurement. Buffer and sample values are required for each calibration. The zero point deviation range is $\pm 2\text{pH}$.

NOTE : Offset is only performed during zero drift.

- **ORP Calibration**

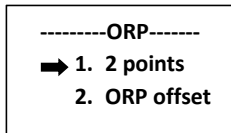

Figure 13

2 points calibration :

- ① After entering the ORP calibration interface, first put the ORP electrode into the 86mV standard solution, and let it stand for a while. After the displayed value is stable, press the [ENT] button.
- ② Clean the electrode with distilled water, dry the water stains, and then set the ORP Put the electrode into the 256mV standard solution and let it stand for a while. After the displayed value is stable, press the [ENT] button.
- ③ After the calibration is successful, the ORP calibration process ends.

ORP offset :

The measured ORP can be corrected, and the correction range is $\pm 300\text{mV}$.

(2) Temperature offset

The temperature value of automatic temperature compensation can be corrected, and the correction range is $\pm 20.0^\circ\text{C}$.

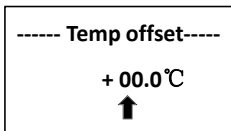

Figure 14

(3) Parameter

It can display the zero point and slope of calibration.

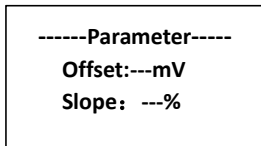
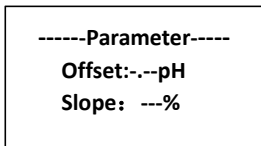

Figure 15

(4) Historical parameters

After the instrument is calibrated, the latest two calibration data are automatically stored, and the historical parameters can be viewed by selecting the calibration date

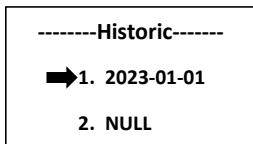

Figure 16

5.2. Setup

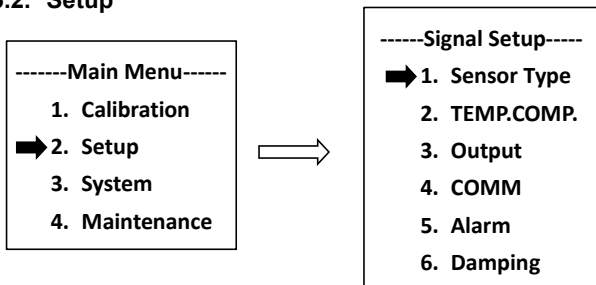

Figure 17

(1) Sensor Type

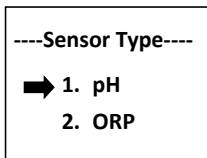

Figure 18

Set the type of electrode, two types of pH electrode and ORP electrode can be set.

(2) Temperature compensation

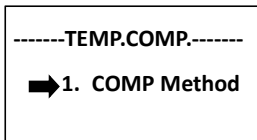

Figure 19

Compensation method: automatic temperature compensation or manual temperature compensation can be set. Automatic temperature compensation, temperature electrode NTC 10K, Pt1000 or Pt100 can be set. Manual temperature compensation: temperature setting range (-10~130) °C.

(3) Output

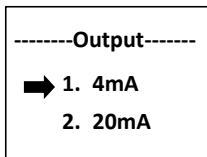

Figure 20

The channel setting can set the parameters of the transmission output of this channel, and each parameter can set the corresponding value of 4mA and 20mA of (4~20)mA output.

(4) Communication

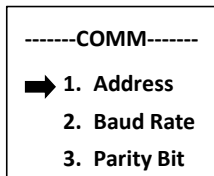

Figure 21

The address (1~247) , baud rate (2400bps, 4800bps, 9600bps,19200bps or 38400bps) and parity bit (N81,N82,E81,O81) of RS485 communication can be set.

(5) Alarm

Figure 22

High Value: When the measured value is greater than the high alarm pull-in value, the high alarm relay pulls in, and when the measured value is less than the high alarm cut-off value, the high alarm relay is disconnected.

Low Value: When the measured value is less than the low alarm pull-in value, the low alarm relay is closed, and when the measured value is greater than the low alarm cut-off value, the low alarm relay is disconnected.

(6) Damping

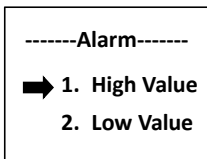
Figure 23

Measurement and transmission damping time (0s~9s) can be set, the greater the damping time, the slower the change of measurement and output value.

5.3. System

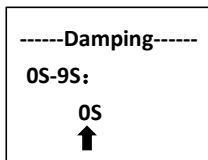
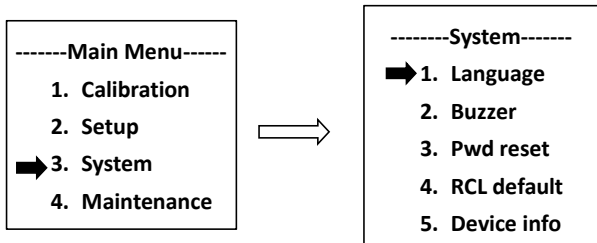

Figure 24

(1) Language

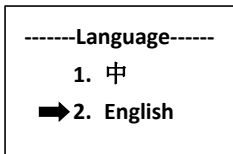

Figure 25

Set the type of language, Chinese and English can be set.

(2) Buzzer

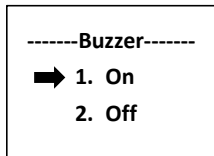

Figure 26

Set the switch of the buzzer when alarming.

(3) Password reset

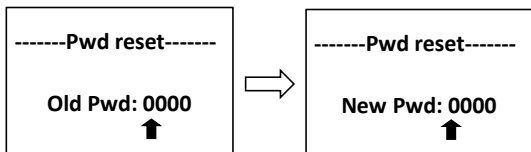

Figure 27

Change the password and log in with the new password.

(4) Recall default

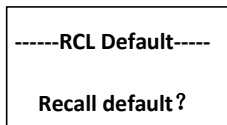

Figure 28

Restore to factory settings.

(5) Device information

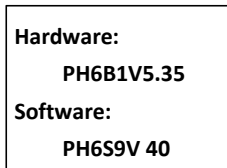

Figure 29

Query the current hardware and software version.

5.4. Maintenance

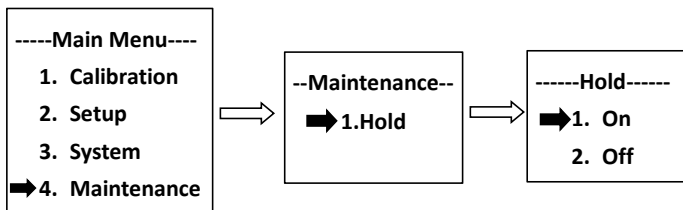



Figure 30

Before the instrument is about to perform maintenance work (such as calibration work, electrode replacement, maintenance work, etc.), this operation can keep the current output current constant, so as to avoid false alarms caused by signal changes during maintenance work and interfere with the operation of downstream chain equipment. There are symbol  prompts, as shown in the figure:

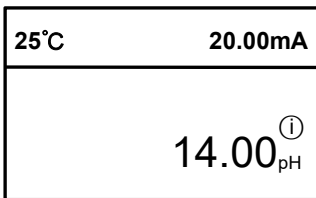

Figure 31

Chapter6 Maintenance

- The storage of pH glass electrode, short-term:
stored in the pH = 4 buffer solution;
long-term: stored in the pH = 7 buffer solution.
- pH glass electrode cleaning
pH glass electrode cleaning glass electrode bulb contamination may make the electrode response time longer. CCl₄ or soap can be used to wipe the dirt, and then immersed in distilled water a day and night to continue to use. When the pollution is serious, can be 5% HF solution for 10 to 20 minutes, immediately rinse with water, and then immersed in 0.1N HCl solution for a day and night to continue to use.
- Glass electrode aging treatment
The aging of the glass electrode and the gradual change in the structure of the glue layer. Previous electrode response slowly, film resistance is high, slope is low. Exfoliation of the outer layer with hydrofluoric acid can often improve electrode performance. If this method can be used to regularly remove the inner and outer layers, the electrode life is almost unlimited.
- The storage of the reference electrode
Silver - silver chloride electrode The best storage solution is saturated potassium chloride solution, high concentration of potassium chloride solution can prevent the silver chloride in the liquid junction precipitation, and maintain the liquid junction in the work status. This method is also applied to the storage of composite electrodes.

- The reference electrode regeneration reference electrode problems caused by the vast majority of liquid junction caused by blockage, the following methods can be resolved:
 - Soaking fluid interface: 10% saturated potassium chloride solution and 90% distilled water mixture, heated to 60 ~ 70 °C, the electrode immersed in about 5cm, soak for 20 minutes to 1 hour. This method dissolves the crystallization of the electrode tip.
 - Ammonia Soaking: When the liquid interface is blocked by silver chloride can be leaching with concentrated ammonia. The specific method is to clean the electrode, the liquid vent after immersion in ammonia 10 to 20 minutes, but do not let ammonia into the electrode inside. Remove the electrode with distilled water to wash, re-add the internal liquid and continue to use.
 - Vacuum method: the hose to match the reference electrode fluid interface, the use of water suction pump, suction part of the liquid through the fluid interface, remove the mechanical blockage.
 - Boiling fluid junction: silver - silver chloride reference electrode liquid interface immersed in boiling water for 10 to 20 seconds. Note that the next time you boil, the electrode should be cooled to room temperature.
 - When the above methods are invalid, sandpaper grinding can be used to remove the mechanical method of grinding. This method may cause the sand under the grinding into the liquid interface. Causing permanent clogging.

Chapter7 Troubleshooting

The users must read this manual carefully before installation and using. The instrument should be operated correctly in accordance with the contents of this manual to confirm whether the installation and use environment meets the requirements. The following table is the possible faults encountered by the pH / ORP controller. The user can eliminate the problems according to the troubles.

Table 3

Problems	Solutions
The signal data is displayed incorrectly or displays "---"	Wiring error: please check whether the input signal cable is connected correctly
	Range exceeded: the measured value exceeds the range
No display on LCD	Please make sure that the power supply wiring is correct and the power supply can supply power normally
The values jumps up and down	Check whether there are interference devices such as inverters around, pay attention to stay away from these interference devices or do shielding measures

Problems	Solutions
The controller cannot be calibrated	The standard solution is incorrectly prepared or the electrode is damaged
The instrument can not measure accurately after calibration with a standard solution of pH4.00、pH6.86、pH9.18	The standard solution may be contaminated, please replace the standard solution to re-calibrate
Value response slowly	The electrode bulb may be covered by dirt, and the reaction will be slow. Please clean it according to the type of pollutant. The slow reaction rate in winter is a normal phenomenon

Chapter8 Communication

The instrument is provided with standard RS485 series communication interface, in accordance with international universal standard MODBUS-RTU communication protocol, supporting No.03 register reading and holding command.

Table 4 Communication data and register address.

Name	Register	Function code	Data type	Access Type	Description
pH value	0x2001	0x03	short	R	Range: 0 ~ 1400
Decimals and units	0x2002	0x03	short	R	Decimal Places: 2 Unit: pH
Temperature value	0x2003	0x03/0x06	short	W/R	Range:-100~1300
Decimals and units	0x2004	0x03	short	R	Decimal Places: 1 Unit: °C
PH sensor voltage value	0x2005	0x03	short	R	Range: -500~500mV
Decimals and units	0x2006	0x03	short	R	Decimal Places: 0 Unit: mV
ORP value	0x2007	0x03	short	R	Range: -2000 ~ 2000mV
Decimals and units	0x2008	0x03	short	R	Decimal Places: 0 Unit: mV

Communication case:

Communication case:

The computer sends: 00 03 00 00 00 01 85 DB

pH / ORP Table Returns: 00 03 02 02 AE 05 58

Return command comment:

00 is RS485 communication address;

03 is the function code;

02 is the data length of the return pH value: 2 bytes;

02 for the return of the pH value of 686 (hex high byte);

AE for the return of the pH value of 686 (hex low byte);

05 58 is the CRC check value;

Chapter9 Warranty & After-sales Service

We promise to the customer that the hardware accessories provided during the supply of the instrument have no defects in material and manufacturing process.

From the date of the purchase, if the user's notice of such defects is received during the warranty period, the company will unconditionally maintain or replace the defective products without charge, and all non customized products are guaranteed to be returned and replaced within 7 days.

Disclaimers:

- During the warranty period, product faults caused by the following reasons are not in the scope of Three Guarantees service
- Product faults caused by improper use by customers.
- Product faults caused by disassembling, repairing and refitting the product.

After-sales service commitment:

- We promise to deal with the customer's technical questions within 2 hours.
- For the instruments returned to the factory for maintenance, we promise to issue the test results within 3 working days and the maintenance results within 7 working days after receiving them.